

Chapter 12

Configuring Channelized OC Modules

This chapter describes how to create and configure DS3 and DS1 interfaces on cOCx/STMx channelized optical carrier (OC) line modules.

This chapter contains the following sections:

- Overview on page 167
- Configuration Tasks on page 169
- Configuring Modules on page 169
- Configuring a Line Interface on page 171
- Configuring SONET Paths on page 173
- Configuring DS3 Interfaces on page 176

Overview

OC modules provide high-speed communications between E-series routers and core routers in an ATM network. You can configure two versions of channelized OC (cOC) modules using the NMC-RX application: cOC3 and cOC12.

In E-series devices, OC line modules pair with I/O modules to provide particular capabilities and connections. For more information about channelized OC modules, see Table 39 and the *JUNOS Physical Layer Configuration Guide*.

Table 39: Channelized OC Line Modules and I/O Modules

Line Module	I/O Module	Description	NMC-RX Software Reference Name
cOCx/STMx	cOC3/STM1	4-port, channelized OC3/STM1 for Frame Relay	COC3 FRAME-4 port
	cOC12/STM4	1-port, channelized OC12/STM4 for Frame Relay	COC12 FRAME-1 port

DS3 and DS1 interfaces are not automatically created on cOCx modules—you must manually create them. You can stack DS3 and DS1 interfaces in multiple ways (see Figure 15).

You can designate a cOCx line module for T1 or E1 connections. Mapping to T1 or E1 does not affect the device; however, the operation mode of the DS1 interfaces that you created on the line module is set to T1 or E1.

Figure 15: cOC3 Line Module Stacking Example

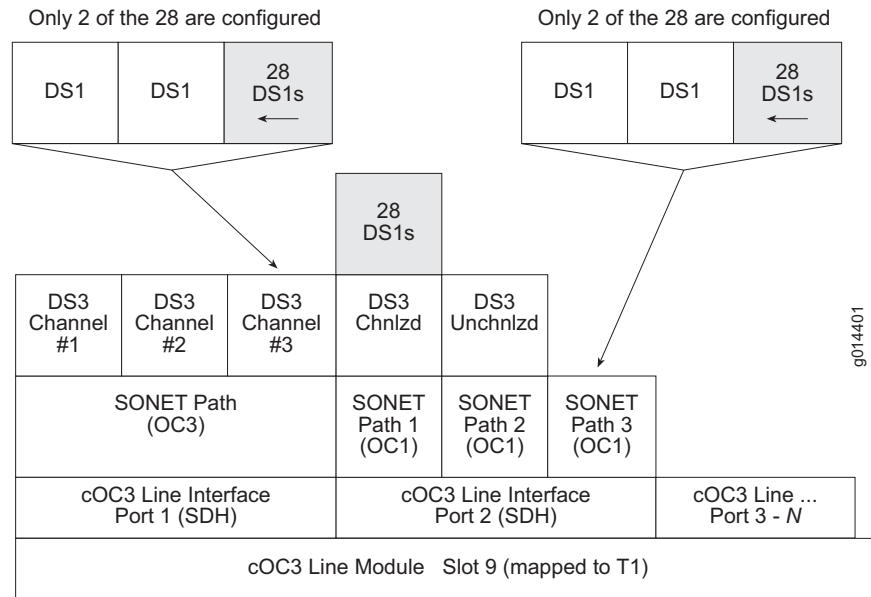

- Example 1** In Figure 15, ports 1 and 2 have cOC3 line interfaces configured with SDH mode. In SDH mode, you can create SONET paths of OC1/STM0 or OC3/STM1 speed. All OC3-speed SONET paths have three DS3 channels that indicate the DS3 channel number of the DS1 interfaces that are created on them. On OC1-speed SONET paths, the DS3 channel is always 1. There are no DS3 interfaces on port 1 in this example, because you cannot create DS3 interfaces on OC3-speed SONET paths.
- Example 2** Port 2 has an OC1-speed SONET path on a cOC3 line interface in SDH mode. SONET path 1 has a channelized DS3 interface, which has 28 DS1 interfaces that are automatically generated when you create the DS3 interface. There are 28 DS1 interfaces because the module is mapped to T1 operation mode. If you map the card to an E1 line module, you cannot create DS3 interfaces.
- Example 3** SONET path 2 on port 2 has an unchannelized DS3 interface with no DS1 interfaces (DS1 interfaces cannot exist on unchannelized DS3 interfaces). Instead, you can create Cisco HDLC, Frame Relay, and PPP directly on unchannelized DS3 interfaces.

Configuration Tasks

To configure a channelized OC module, complete the following tasks:

1. Enable or disable the line module.
2. Map the line interface to T1 or E1.
3. Set the line interface parameters.
4. Configure SONET paths and map DS1 interfaces, if applicable.
5. Create DS3 interfaces.

Configuring Modules

You can configure only the admin status of a module.

To configure a module:

1. In the Instance Explorer list, select the module that you want to configure.
2. Right-click, and select either Map to T1 or Map to E1.

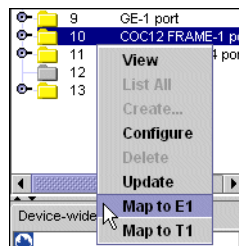

3. Right-click again, and click Configure.

The Module Config tab appears in the work area. Note that the operation mode is set to the option you chose in Step 2.

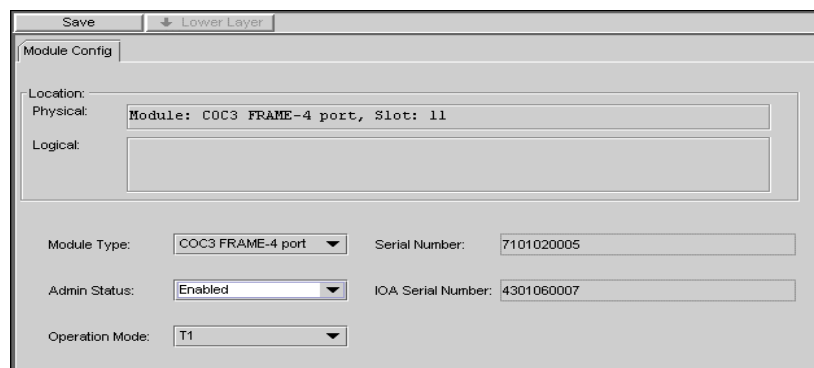

4. Set the admin status (Table 40).

Table 40: Module Configuration Parameters

Field	Description
Module Type	Module type (cannot edit)
Admin Status	<ul style="list-style-type: none"> ■ Enabled—Module is running ■ Disabled—Module is not in operation
Operation Mode	Displays if module is mapped to a T1 or E1 line module
Serial Number	Ten-digit identification number (S/N) on the faceplate of the module. This value is automatically retrieved from the device, and you cannot edit it.
IOA Serial Number	Ten-digit identification number (S/N) on the faceplate of the input/output adapter. This value is automatically retrieved from the device, and you cannot edit it.

5. Click Save.

Configuring a Line Interface

To configure a line interface:

1. In the Instance Explorer, select the line interface that you want to configure.
2. Right-click, and select Configure.

The OC Config tab appears in the work area.



NOTE: The Sonet Path Speed parameter does not appear for cOC12 line modules.

Save Lower Layer

OC3 Config

Location:

Physical: Module: C0C3 FRAME-4 port, Slot: 11, Port: 1

Logical:

Name: SONET11/1 Status:

Operational: Up

Administrative: Up

IfIndex: 117440515

Transmit Clock: Loop Timing Synchronous Mode: SONET

Sonet Path Speed: OC1 Loopback Mode: No Loopback

3. Set the line interface parameters (Table 41).

Table 41: Line Interface Parameters (OC3)

Field	Description
Name	Identifier for the interface; generated automatically
Alias	Description of the interface; 0–15 characters; default: blank
IfIndex	Identifier for the interface on the particular line interface; generated automatically
Operational	Current operational status of the interface
Administrative	Desired status of the interface: Up/Down; default: Up
Transmit Clock	<ul style="list-style-type: none"> ■ Loop Timing—device receives its clocking from a network source ■ Internal Module—device receives its clocking from a network source ■ Internal Chassis—device receives its clocking from the configured system clock
Sonet Path Speed	<ul style="list-style-type: none"> ■ Speed for SONET paths generated on the line interface <ul style="list-style-type: none"> ■ OC3—Creates an OC3 SONET path with three DS3 channels on top of the line interface ■ OC1—Creates three OC1 paths on top of the line interface ■ Unspecified—Does not allow you to create or delete anything on the interface ■ Enabled only when SDH is selected for synchronous mode ■ Disabled if there are any DS3 or DS1 interfaces on the line interface ■ Not visible for cOC12 line modules
Synchronous Mode	<ul style="list-style-type: none"> ■ SONET—Synchronous Optical Network <ul style="list-style-type: none"> ■ disables Sonet Path Speed field and sets to it OC1 ■ SDH—Synchronous Digital Hierarchy <ul style="list-style-type: none"> ■ enables Sonet Path Speed field
Loopback Mode	<ul style="list-style-type: none"> ■ No Loopback—Disables loopback mode ■ Line Loopback—Loops the data toward the network; connects the received network signal directly to the transmit network signal line ■ Internal Loopback—Loops the data toward the interface of the module; connects the local transmitted signal to the local received signal

4. Click Save.

Configuring SONET Paths

You can configure SONET paths on cOC12 line modules. You can create SONET paths or delete SONET paths from a line interface using the Configure Sonet Paths dialog box.

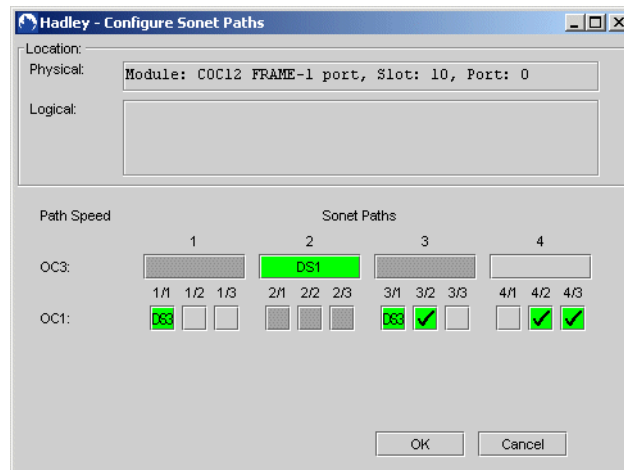

When a cOC12 line interface is in SDH mode, the interface can contain both OC3- and OC1-speed SONET paths, which enables you to create multiple SONET paths of varying speeds.

Each check mark indicates a SONET path that is selected, or one that already exists with no stacking other than DS3 channels on it. When a SONET path is selected, any SONET path that is directly above or below it is deselected. These SONET paths overlap and cannot exist simultaneously. SONET paths with a DS3 or DS1 interface are labeled DS3 and DS1, respectively, and you cannot deselect them. SONET paths that overlap with these SONET paths appear dimmed, and you cannot select them.

If you configure the cOC12 line interface with Synchronous Mode set to SONET, OC3-speed SONET paths are not allowed and are disabled in the Configure Sonet Paths dialog box.

For detailed information about SONET paths, see *JUNOS Physical Layer Configuration Guide, Chapter 5, Configuring Channelized OCx/STMx Interfaces*.

To configure a SONET path:

1. On a cOC12 line module, click a line interface.
2. Right-click and select Configure Sonet Paths.

The Configure Sonet Paths dialog box appears.

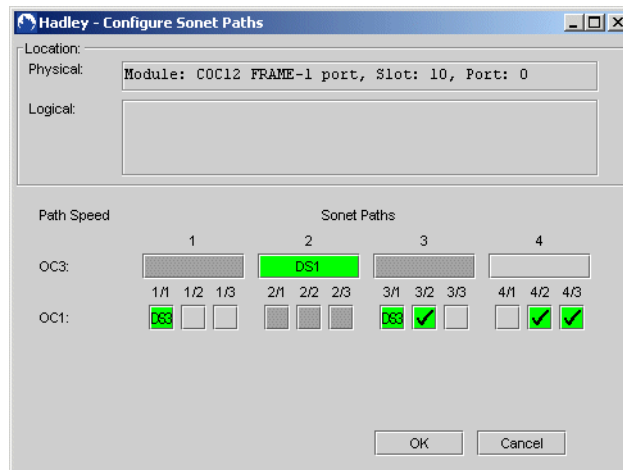

3. Select the desired paths by clicking the necessary box(es).



NOTE: If a line interface is already configured with other SONET paths and the paths have DS3 or DS1 interfaces on them, you cannot create or modify the paths until you remove the DS3/DS1 interfaces.

4. Click OK.

The SONET path hierarchy appears in the Instance Explorer.

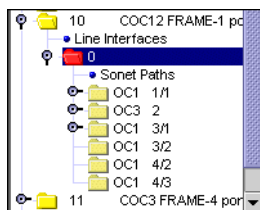

Mapping and Removing DS1 Interfaces on an OC1 SONET Path

You can map a DS1 interface on an OC1 SONET path if there are no other objects on the path.

- In T1 mode, you can create 28 DS1 interfaces.
- In T3 mode, you can create 21 DS1 interfaces.

To map DS1 interfaces:

1. Select an OC1 SONET path.
2. Right-click, and select Map to DS1.

The DS1 Interfaces hierarchy appears in the Instance Explorer.

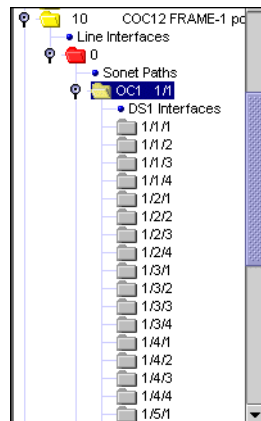

To remove the mapping:

1. Select the OC1 SONET path that contains the DS1 interfaces.
2. Right-click, and select Remove DS1s.

The items are deleted.



NOTE: For information about configuring DS1 interfaces, see *Configuring a DS1 Interface* in *Chapter 16, Configuring T3/E3 and T1/E1 Modules*.

DS3 Channels

DS3 channels are located only on OC3-speed SONET paths that are created on cOC3/cOC12 line interfaces set to SDH mode. Each OC3 SONET path has three DS3 channels numbered 1–3. This number is the path payload number of any DS1 interface that is configured on top of the DS3 channel.

For example, the first DS1 interface that is configured on top of the DS3 channel is numbered 1/1/1, 1/1/2, 1/1/3, and 1/1/4. The second DS1 interface is numbered 1/2/1, 1/2/2, 1/2/3, and 1/2/4, and so forth.

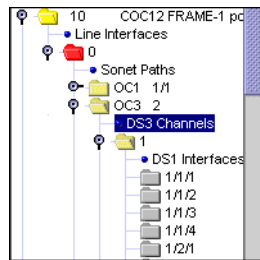

To learn how to map and remove DS1 interfaces on DS3 channels, see *Mapping and Removing DS1 Interfaces on an OC1 SONET Path* on page 175.

Configuring DS3 Interfaces

You can create a DS3 interface on a SONET path only if the SONET path speed is OC1 and there are no other objects on the SONET path. DS3 interfaces can be channelized or unchannelized. When you create a channelized DS3 interface, twenty-eight DS1 interfaces are created. An unchannelized DS3 interface includes HDLC settings.

Customers profiles are not listable from DS3 interfaces on cOC3/12 modules.



For information about configuring DS1 interfaces, see *Configuring a DS1 Interface* in *Chapter 16, Configuring T3/E3 and T1/E1 Modules*.

To create a DS3 interface on a SONET path:

1. Select an OC1 SONET path.
2. Right-click, select Create, and click DS1 Interface.

The Create DS3 Interface dialog box appears.

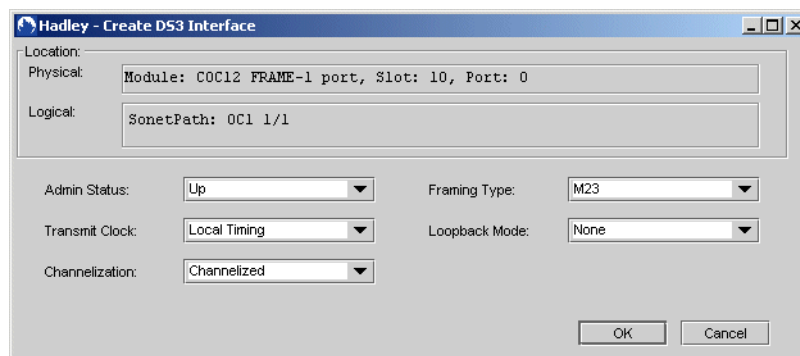

NOTE: If DS1 interfaces are already mapped to the OC1 SONET path, you must unmap the interfaces before you create a DS3 interface.

3. Set the DS3 interface parameters (Table 42).

Table 42: DS3 Interface Parameters

Parameter	Description
Admin Status	<ul style="list-style-type: none"> ■ Up—Module is enabled ■ Down—Module is disabled
Transmit Clock	<ul style="list-style-type: none"> ■ Loop Timing—Device receives its clocking from a network source ■ Internal Module—Device receives its clocking from a network source ■ Internal Chassis—Device receives its clocking from the configured system clock
Channelization	<ul style="list-style-type: none"> ■ Channelized ■ Unchannelized
Framing Type	<p>Method for distinguishing digital channels that are time-division multiplexed together</p> <ul style="list-style-type: none"> ■ M23—M23 multiplexer framing ■ CbitParity—C-bit parity framing
Loopback Mode	<ul style="list-style-type: none"> ■ No Loopback—Disables loopback mode ■ Line Loopback—Loops the data toward the network; connects the received network signal directly to the transmit network signal line. ■ Internal Loopback—Loops the data toward the interface of the module; connects the local transmitted signal to the local received signal.
HDLC Settings	(Appears only if Unchannelized was selected during initial creation; visible later during Configure mode only.)
CRC Checking Enabled	Cyclical redundancy check (CRC) is an error-checking technique
Data Inversion	Provides <i>ones density</i> , a method for inserting 1s in the data stream. If you enable data inversion on your device, be sure it is also turned on at the other end of the line on the destination device.

Table 42: DS3 Interface Parameters (continued)

Parameter	Description
MTU	Maximum transmission unit; the largest size allowed for a data packet transmitted over a transmission line; range 4–32763; default 1024 bits
MRU	Maximum receive unit; the largest size allowed for a data packet received over a transmission line; range 4–32763; default 2048
CRC Algorithm	Cyclical redundancy check (CRC) can be set to 16 bits or 32 bits; default 16 bits

4. Click OK.

The DS3 interface and related DS1 interfaces are created.