

## Chapter 11

# Configuring Bulk Services

The NMC-RX application allows you to configure a suite of services for Asynchronous Transfer Mode (ATM). This suite is called bulk services and provides the IP over ATM service.

Topic	Page
Overview	125
References	126
Creating Core Components	126
Creating IP over ATM Service	127
Selecting a Service Type	147
Creating ATM Service Type	148
Creating Bridged 1483/ATM Service Type	151
Creating PPP/ATM Service Type	158
Creating PPPoE/ATM Service Type	163

### Overview

---

The NMC-RX bulk services capability allows you to configure multiple instances of the components that make up the IP over ATM service from a single access point. However, if you configure each individual component separately, you need to navigate through multiple access points.

You can choose to create bulk services on an ATM subinterface or on a nonbroadcast multiaccess (NBMA) interface.

If you choose the ATM subinterface path, you can create the following service types:

- ATM
- Bridged 1483/ATM
- PPP/ATM
- PPPoE/ATM

If you choose the NBMA interface path, you can create only the IP over ATM service. See Figure 5.

The bulk services suite allows you to provision *sets* of components and provides the following enhancements to the NMC-RX application:

**Naming**—You can enter the name for the service once, and it will be propagated to all components in the service. This effectively generates each component's *logical* name.

**Required fields**—Each component's required fields are highlighted in blue. This clearly identifies which parameters must be set.

## References

---

For information about the parameters for the IP over ATM service, see:

*NMC-RX User Guide , Vol. 1, Chapter 17, Configuring ATM*—For ATM interfaces, subinterfaces, circuits, VP tunnels, and PPP interfaces

*NMC-RX User Guide , Vol. 1, Chapter 19, Configuring Bridged IP*—For bridged IP (1483) interfaces

*NMC-RX User Guide , Vol. 1, Chapter 27, Configuring PPP over Ethernet* —For PPPoE interfaces and subinterfaces

*Chapter 6, Configuring IP* —For IP addresses

## Creating Core Components

---

The core components that can be created for the bulk services supported by the NMC-RX application are:

An ATM interface

(Optional) VP tunnel(s)

ATM subinterface(s) or NBMA interface(s)

ATM circuit(s)

(Optional) IP address(es)

When you create the *ATM* service, you can create these components. You can then create the other service types as choices within IP over ATM.

## Creating IP over ATM Service

The ATM service allows service providers to receive traffic from subscribers who have customer premises equipment (CPE), such as routers, with ATM interfaces.

When you create IP over ATM service, you begin by selecting either ATM interface or services from the line interface. Create the following components in the following sequence:

1. An ATM interface—You can create only a single ATM interface on a line interface.
2. VP tunnel(s)—You can create no tunnels or multiple tunnels.
3. ATM subinterfaces—You can create multiple ATM subinterfaces on a single ATM interface.
4. ATM circuits—You can create multiple ATM circuits, one for each ATM subinterface.
5. IP addresses—You can create multiple IP addresses for each IP interface.

You can begin the process of creating bulk services on an E-series device by creating services from an ATM module's line interface, as shown in Figure 5.

Figure 5, Figure 6, and Figure 7 illustrate the sequence of NMC-RX screens that you must navigate to create bulk services on an E-series device. Figure 5 presents the sequence up to selecting a service type.

**Figure 5: Beginning the Process for Creating Bulk Services**

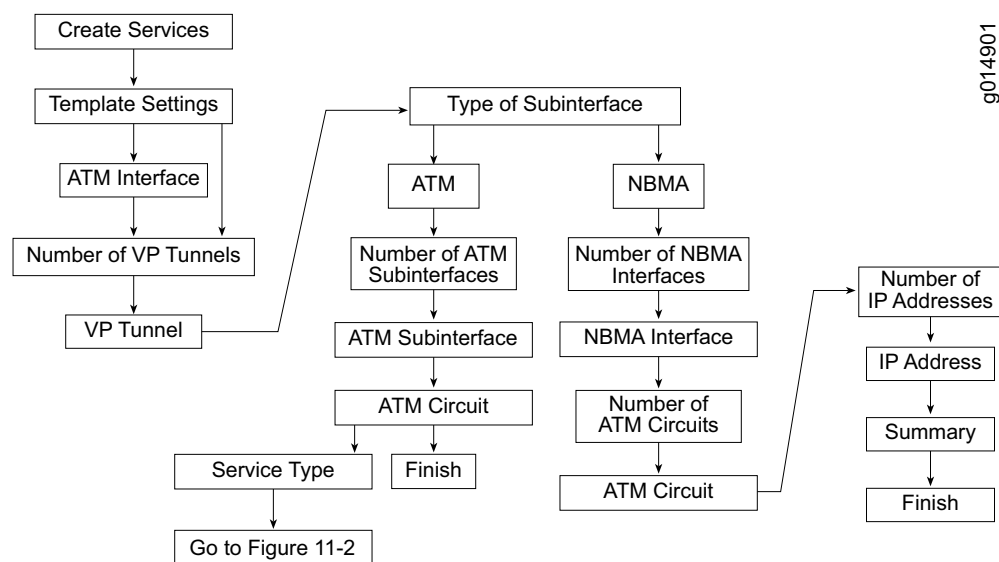
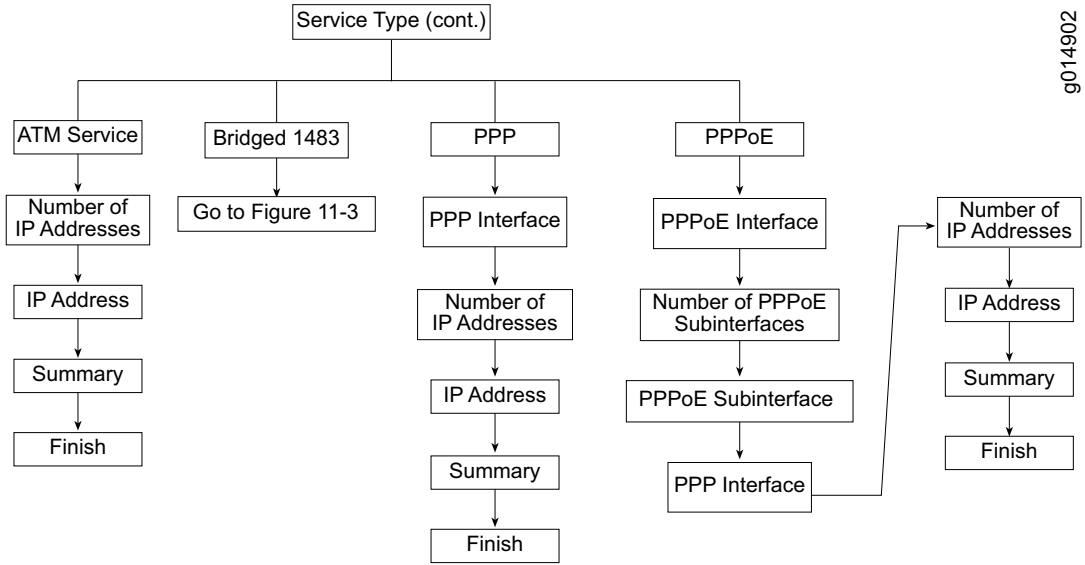

Figure 6 continues the bulk services wizard from the point of selecting service types.

Figure 6: Continuing the Process for Creating Bulk Services



g014902

Figure 7 continues the bulk services wizard from the point of selecting the Bridged 1483 service type.

Figure 7: Configuring the Bridged 1483 Service Type

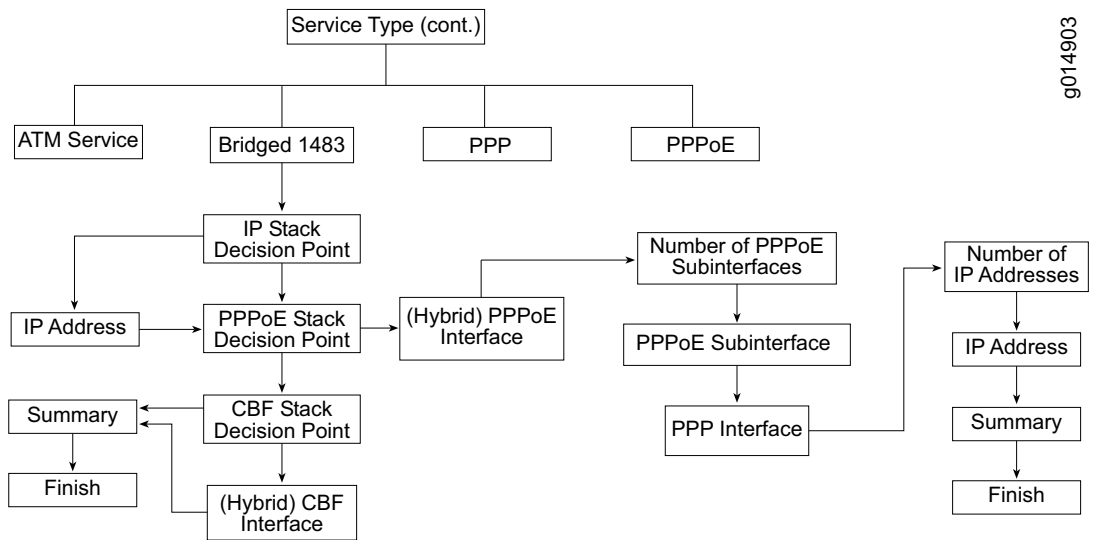

g014903

To create IP over ATM service:

1. In the Instance Explorer, double-click a module that supports ATM, such as an OC3-ATM.
2. Click a line interface, right-click, select Create, and click Services.

The Template Settings dialog box appears.

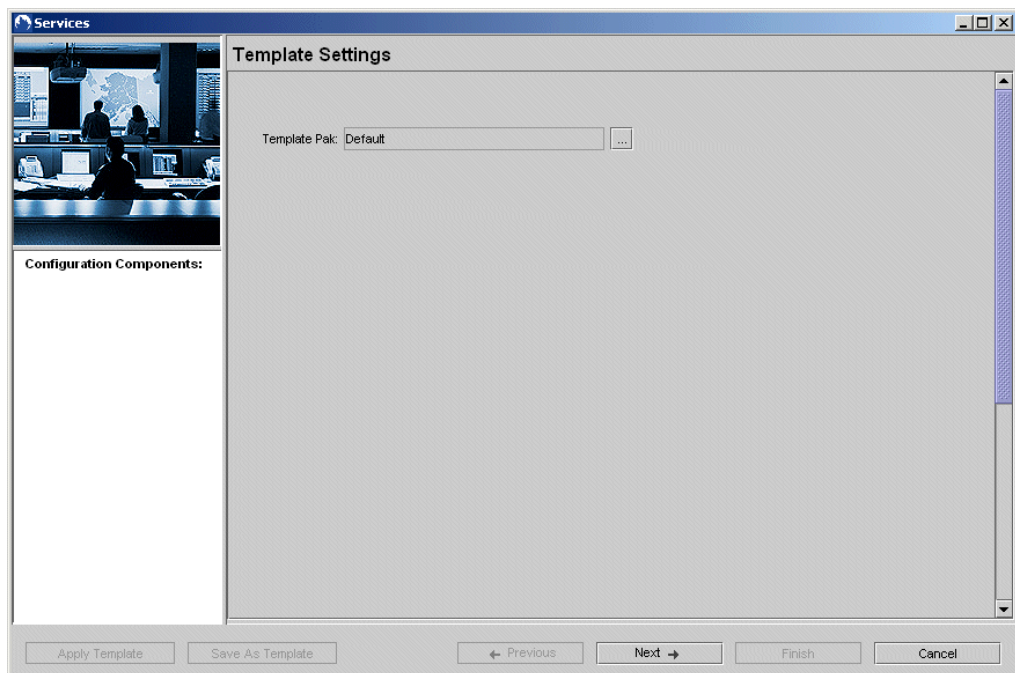

Use the default Template Pak name for the service you are creating, or select an existing template pak. For information about selecting an existing template, see *Select Template Pak* in *Related Dialog Box* on page 167.

3. Related Dialog Box on page 167 for information about selecting an existing template.
4. Click Next to set either an ATM interface or the number of VP tunnels.

If the ATM Interface dialog box appears, go to *Creating an ATM Interface*.

If the ATM interface has already been created, the Number of VP Tunnels dialog box appears. Go to *Creating VP Tunnels*.

### ***Creating an ATM Interface***

An ATM port can have a major interface and one or more subinterfaces. If you create services on an existing ATM interface, the Number of VP Tunnels dialog box appears after the Template Settings dialog box. Otherwise, the Create ATM Interface dialog box appears.

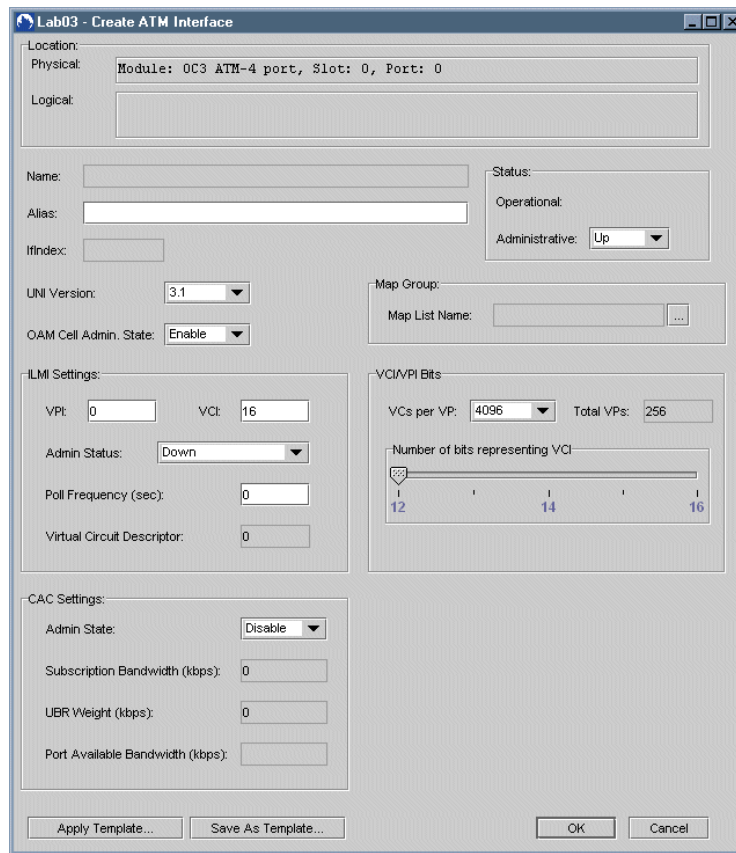

To configure an ATM interface:

1. Set the ATM interface's parameters.

**Table 41: ATM Interface Parameters**

Parameter	Description
Name	Identifies the interface; generated automatically
Alias	Description of the interface; 0–32 characters; default: blank
Ifindex	Identifies the interface on the particular line interface; generated automatically
Operational	Current operational status of the interface
Administrative	Desired status of the interface: Up/Down; default: Up
UNI Version	User Network Interface. You can select the version on a per port basis; the available versions are 3.0, 3.1, and 4.0.
OAM Cell Admin. State	Disabled or Enabled. When enabled, the E-series router ignores all operation, administration, and maintenance (OAM) cells received on the interface.
Map List Name	Associates a map list with the current ATM interface on OCx/STMx modules only. Range 32 characters. <i>See <a href="#">Creating NBMA Interfaces</a> on page 141.</i>

**Table 41: ATM Interface Parameters (continued)**

Parameter	Description
<b>ILMI Settings</b>	
VPI	Virtual path identifier for ILMI; range 0–255. The recommended VPI value for the ILMI PVC is 0. It must match the value on the ATM switch. <b>NOTE:</b> The VPI and VCI values cannot both be set to 0.
VCI	Virtual circuit identifier for ILMI; range 0–65535. The VCI value is unique on a single link, not throughout the ATM network. The recommended VCI value for the ILMI PVC is 16. <b>NOTE:</b> The VCI and VPI values cannot both be set to 0.
Admin Status	Up—Interface is enabled by the administrator. Down—Interface is disabled by the administrator.
Poll Frequency (sec)	You can enable polling on a per port basis. This is the interval in seconds between POLL PDU transmissions if there are no pending sequence data PDUs.
Virtual Circuit Descriptor	VCD. Identifies a virtual circuit descriptor number in the range 1–4294967293. <b>NOTE:</b> The VCD value has no relationship to the VPI and VCI values. It has meaning only to the E-series router.
<b>VCI/VPI Bits</b>	
VCs per VP	Total number of virtual circuits per virtual paths
Total VPs	Total number of virtual paths
Number of bits representing VCI	Changes the number of bits when you slide the toggle. Toggle automatically changes the VCs per VP and Total VPs fields.
<b>CAC Settings</b>	
Admin State	Admin status of CAC on the ATM interface
Subscription Bandwidth (kbps)	Subscribed bandwidth of the ATM interface
UBR Weight (kbps)	Bandwidth associated with every unspecified bit rate (UBR) and UBR with peak cell rate (PCR) connections configured on the ATM interface
Port Available Bandwidth (kbps)	Available bandwidth of the ATM interface as calculated by the device; not editable



**NOTE:** The number of VCI bits you set determines the total number of VPs you can create.

2. Click Next to enter number of VP tunnels information.

## Creating VP Tunnels

Virtual path (VP) tunneling is a feature that allows traffic shaping to be applied to the aggregation of all VCs within a single VP. VP tunnels can be used to ensure that the total traffic transmitted on a VP does not exceed a specifiable maximum peak cell rate (PCR).

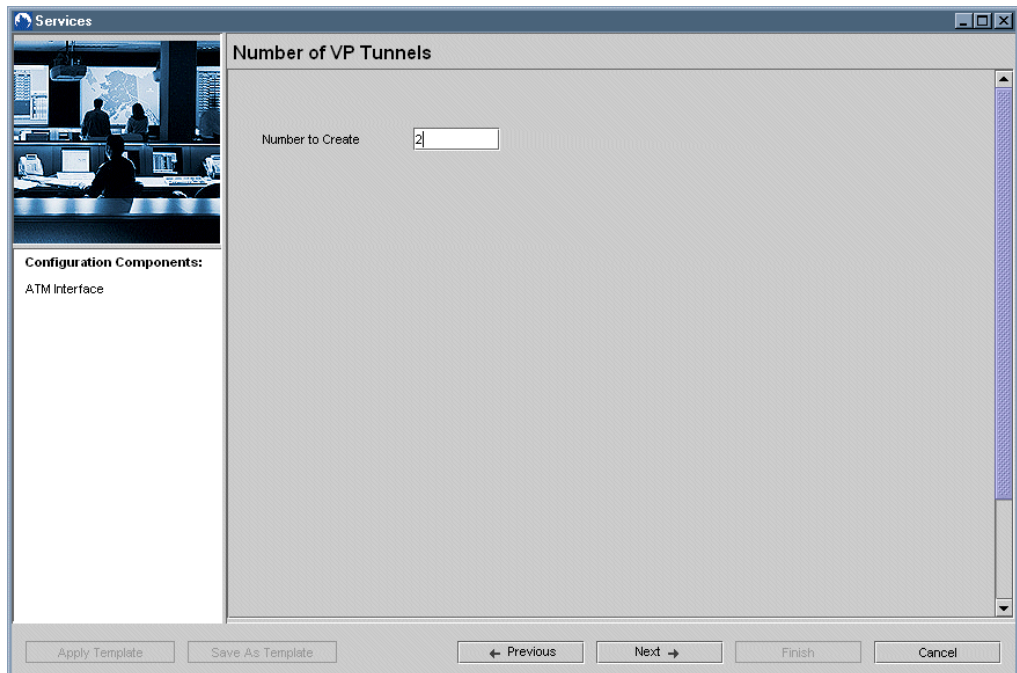

To configure VP tunnels:

1. In the Number to Create text box, enter the number of tunnels, and click Next.

To create no tunnels, enter 0 in the text box. If you enter 0, the next dialog box to appear will be Type of Sub Interface.

If you enter a nonzero number, the VP Tunnel dialog box appears.

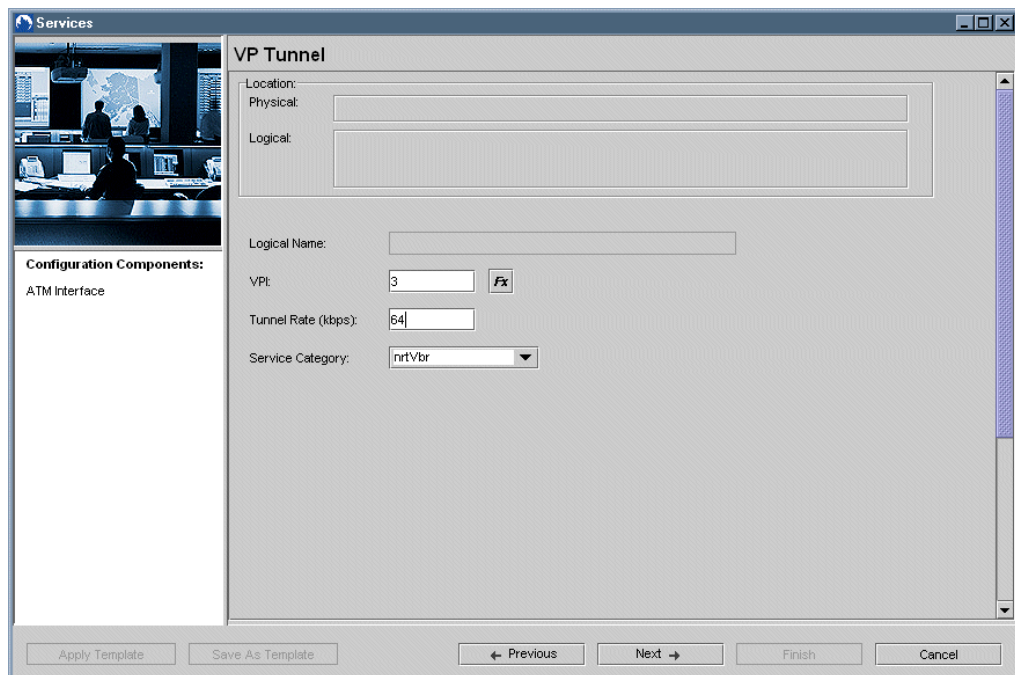

2. Set the VP tunnel parameters.

**Table 42: VP Tunnel Parameters**

Parameter	Description
VPI	Virtual path identifier for VP tunnel; number in the range 0–255 <b>NOTE:</b> VPI and VCI values cannot both be set to 0.
Tunnel Rate (kbps)	Number in the range 1–149760
Service Category	nrtVbr—Non-real-time variable bit rate cbr—Constant bit rate

3. To the right of the VPI text box, click .

The VPI Formula dialog box appears. This dialog box allows you to set the Start and Increment values for VPIs.

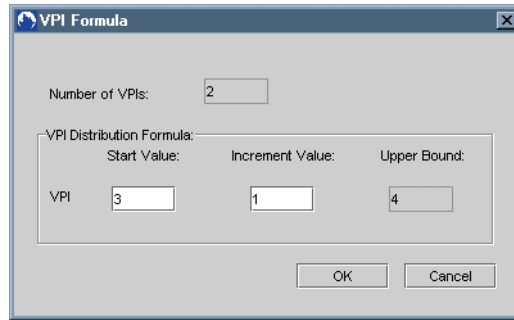

If the ATM interface does not allow any bits for VPI, the settings must both be zero.

4. Click OK to save changes and return to the VP Tunnel dialog box.
5. In the VP Tunnel dialog box, click Next.

The Type of Sub Interface dialog box appears.

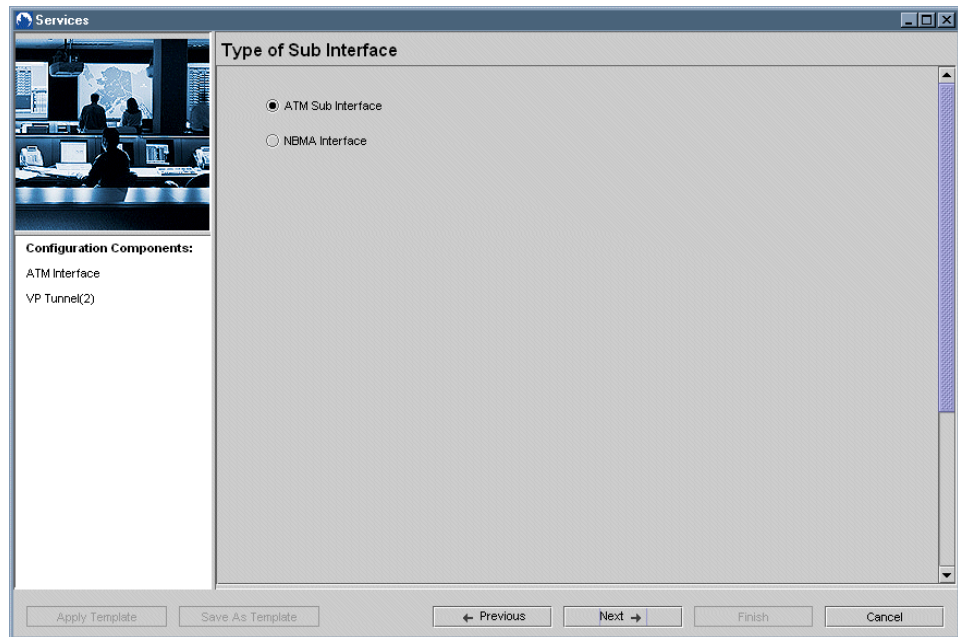

6. Select the type of subinterface you want, and click Next.

If you choose ATM Sub Interface, go to *Creating ATM Subinterfaces*.

If you choose NBMA interface, go to *Creating NBMA Interfaces*.

## Creating ATM Subinterfaces

An ATM subinterface is a mechanism that allows a single physical ATM interface to support multiple logical interfaces. You can create ATM subinterfaces from the major interface or from the VP tunnel with which you want to associate the ATM subinterface.

1. In the Type of Sub Interface dialog box, select ATM Sub Interface, and click Next.

The Number of ATM Sub Interfaces dialog box appears.

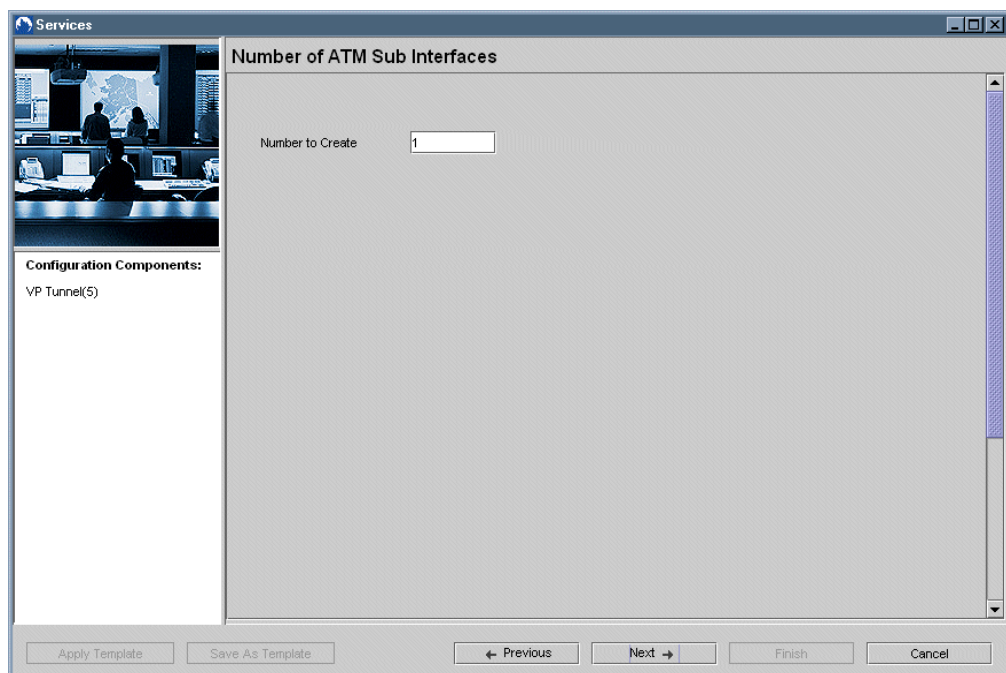

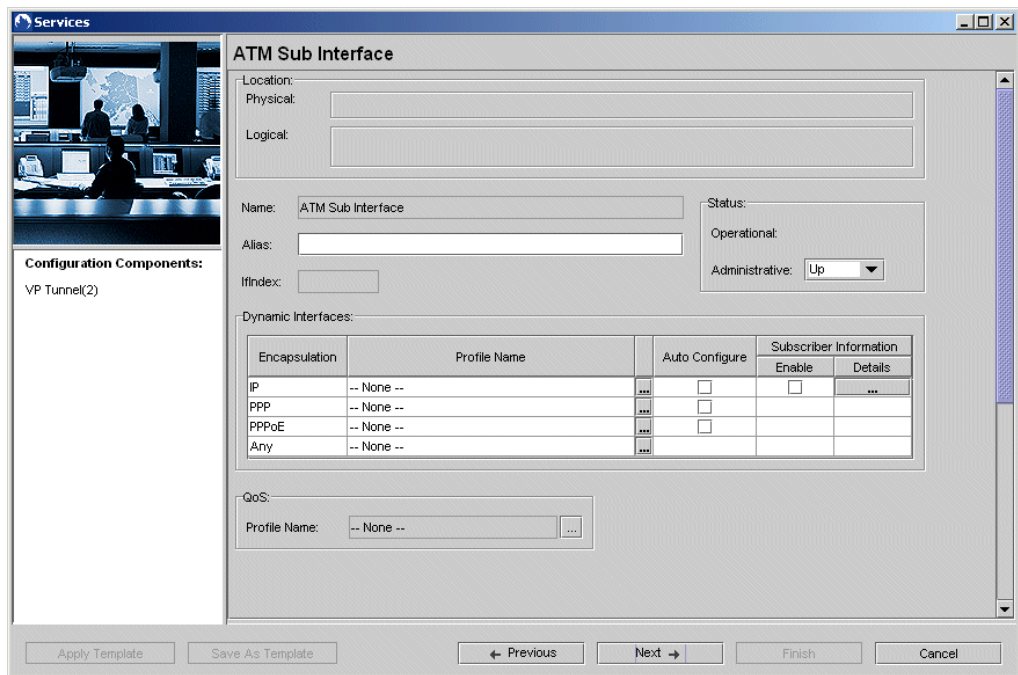

2. Enter the number of ATM subinterfaces you want to create, and click Next.

The ATM Sub Interface dialog box appears.



3. Set the ATM subinterface parameters.

**Table 43: ATM Subinterface Parameters**

Parameter	Description
Name	Identifies the interface; generated automatically
Alias	Description of the interface; 0–15 characters; default: blank
IfIndex	Identifies the interface on the particular line interface; generated automatically
Operational	Current operational status of the interface
Administrative	Desired status of the interface: Up/Down; default: Up
<b>Dynamic Interfaces</b>	
Encapsulation	Specifies the type of dynamic encapsulation that will be accepted and detected by the ATM 1483 subinterface.
Profile Name	Click  to choose a profile from the Associate Profile dialog box.
Auto Configure	When the box is selected, you enable the autoconfiguration feature, which causes the ATM subinterface to support a dynamic interface.
<b>Subscriber Information</b>	
Enable	Select to append subscriber information.
Details	When you select Enable, this field becomes active. Click  to display the Subscriber Details dialog box.  Then configure a local subscriber on the E-series device to support authentication and configuration from RADIUS for a dynamic IPoA interface.

**Table 43: ATM Subinterface Parameters (continued)**

Parameter	Description
<b>QoS</b>	
Profile Name	Click  to choose a profile from the Associate QoS Profile dialog box.

In the Dynamic Interfaces group box, you can set a profile for each encapsulation.

- Click  to the right of the Profile Name column.

The Associate Profile dialog box appears.

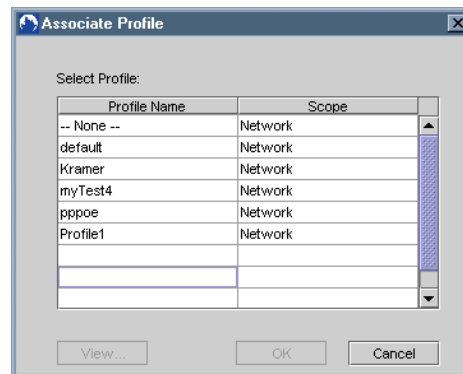

- Select the Profile you want, and click OK to save your selection and to return to the ATM Sub Interface dialog box.

If you want to view the profile you selected, click View.

- In the Dynamic Interfaces group box, you can enable Auto Configure by clicking the check box. If you enable Auto Configure, the ATM subinterface supports dynamic interfaces.
- If you want to display detailed information about a subscriber, double-click the Enable check box in the Dynamic Interfaces pane. This makes the Details button active.
- Click Details.

The Subscriber Details dialog box appears.

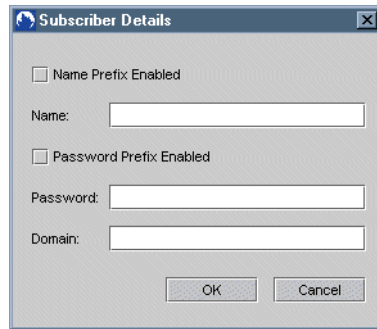

9. Set the parameters, and click OK.

The ATM Sub Interface dialog box appears.

10. Click Next.

The ATM Circuit dialog box appears. Go to *Creating ATM Circuits*.



---

**NOTE:** If you configured dynamic interfaces and selected Auto Configure, the last task you must perform manually is to configure the ATM circuit. The rest of the ATM configuration is completed dynamically.

---

## Creating ATM Circuits

You can create a single ATM circuit on each ATM subinterface. Protocols such as ATM require that you create one or more virtual circuits (VCs) over which your data traffic is transmitted to higher layers in the protocol stack.

To create ATM circuits:

1. In the ATM Sub Interface dialog box, click Next.

The ATM Circuit dialog box appears.

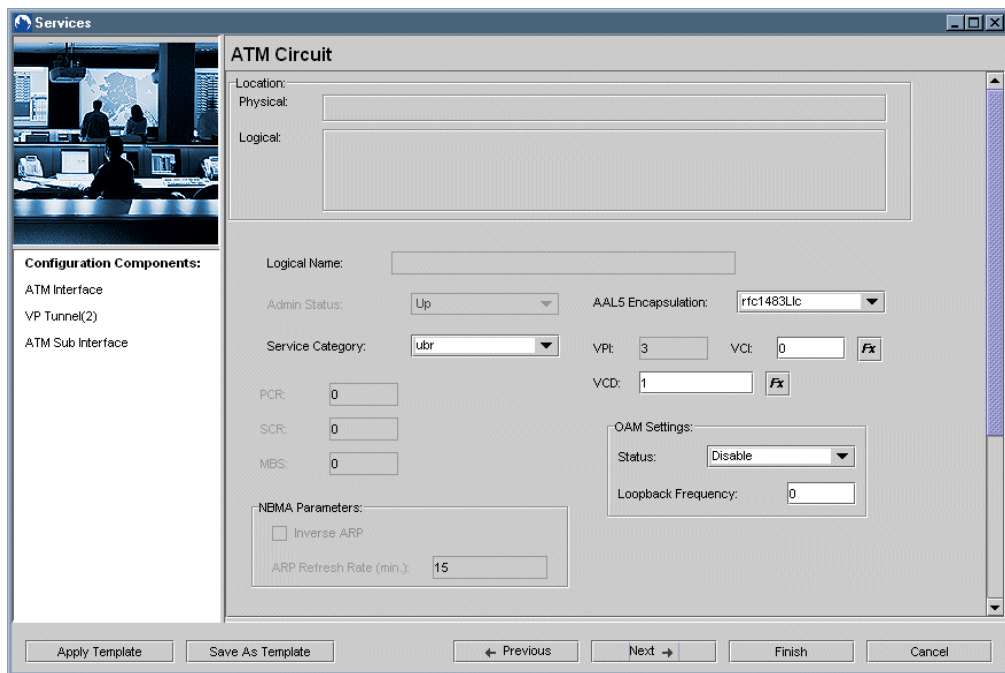

## 2. Set the ATM Circuit parameters.

**Table 44: ATM Circuit Parameters**

Parameter	Description
Admin Status	Select the status from the drop-down list: Up—Interface is enabled by the administrator Down—Interface is disabled by the administrator
AAL5 Encapsulation	Select the encapsulation for the ATM Adaptation Layer 5 (AAL5) from the drop-down list: rfc1483VcMux—aal5muxip rfc1483Llc—aal5snap
Service Category	Service category for traffic management: ubr—Unspecified bit rate traffic management; select if no VCs require traffic shaping. ubrPcr—Unspecified bit rate peak cell rate; select for PCR only. nrtVbr—Non-real-time variable bit rate; can select for PCR, SCR, or MBS. cbr—Constant bit rate; select for PCR only.
VPI	Virtual path identifier; range 0– 55; depends on values set on ATM interface <b>NOTE:</b> The VPI and VCI values cannot both be set to 0.
VCI	Virtual circuit identifier; range 0–65535; depends on values set on ATM interface <b>NOTE:</b> The VCI and VPI values cannot both be set to 0.

**Table 44: ATM Circuit Parameters (continued)**

Parameter	Description
VCD	Virtual circuit descriptor; range 1–4294967295; depends on values set on ATM interface
PCR	Peak cell rate—Value must be greater than or equal to SCR OC3, OC3-ATM, OC12-ATM—Range 1–99999 E3: range 64–30528 T3: range 64–44209
SCR	Sustained cell rate OC3, OC3-ATM, OC12-ATM: range 1–99999 E3: range 64–30528 T3: range 64–44209
MBS	Maximum burst size OC3, OC3-ATM, OC12-ATM: range 1–99999 E3: range 64–30528 T3: range 64–44209
<b>NBMA Parameters</b>	
Inverse ARP	Enables or disables InARP on the circuit
ARP Refresh Rate (Min.)	Specifies refresh rate for ARP in minutes; range 1–60
<b>OAM Settings</b>	
Status	Enable or disable generation of OAM F5 loopback cells on this circuit. This option enables VC integrity features that have an effect on the operational state of the ATM PVC.
Loopback Frequency	Time interval in seconds between transmissions of OAM F5 loopback cells; range 0–600. If this option is not specified, then OAM F5 loopback cells are generated once every 10 seconds.

3. Click  to the right of the VCI text box.

The VPI/VCI Formula dialog box appears.

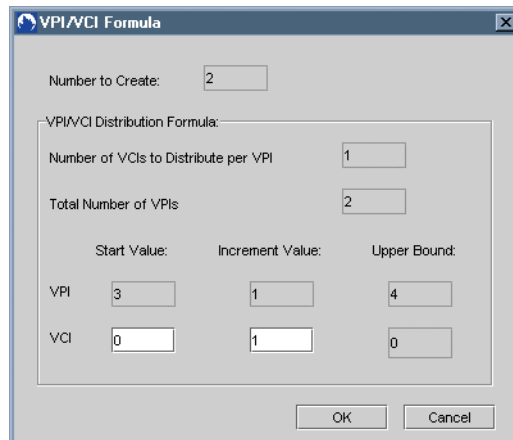

4. Make any changes, and click OK to save the changes and return to the ATM Circuit dialog box.
5. Click  to the right of the VCD box.

The VCD Formula dialog box appears.

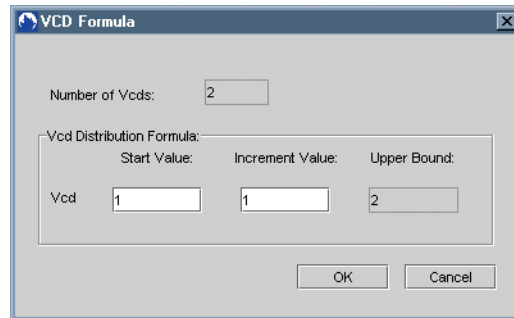

6. Make any changes, and click OK to save the changes and return to the ATM Circuit dialog box.
7. In the ATM Circuit dialog box, click either Finish or Next.

If you click Finish, complete the creation of the IP over ATM service. The IP address and all other service types are optional.

If you click Next, the Service Type dialog box appears.



**NOTE:** Up to this point you have built the basic IP over ATM service. If you continue, you can add interfaces to the protocol stack.

## Creating NBMA Interfaces

The NMC-RX application's bulk services feature allows you to create a nonbroadcast multiaccess (NBMA) service. For information about NBMA, see *Creating an NBMA Interface* in *NMC-RX User Guide, Vol. 1, Chapter 17, Configuring A TM*.



**NOTE:** The NBMA feature is supported only on OC3-4 and OC12 line modules.

To create an NBMA service:

1. Navigate to the Type of Sub Interface dialog box. See *Creating IP over ATM Service* on page 127.
2. Select NBMA Interface, and click Next.

The Number of NBMA Interfaces dialog box appears.

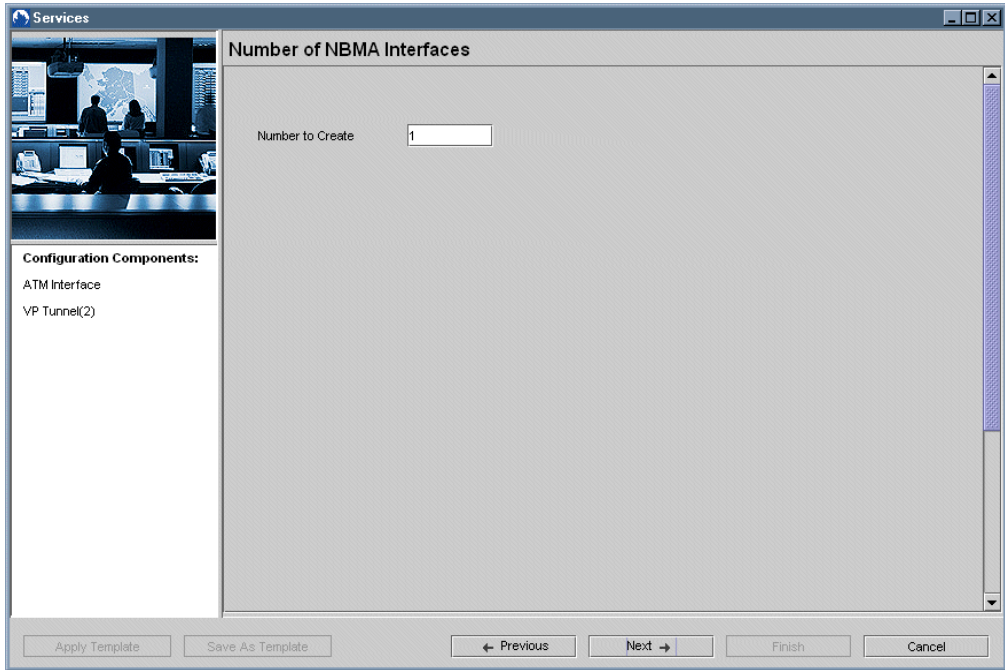

3. Type the number of NBMA interfaces you want to create in the Number to Create text box, and click Next.

The NBMA Interface dialog box appears.

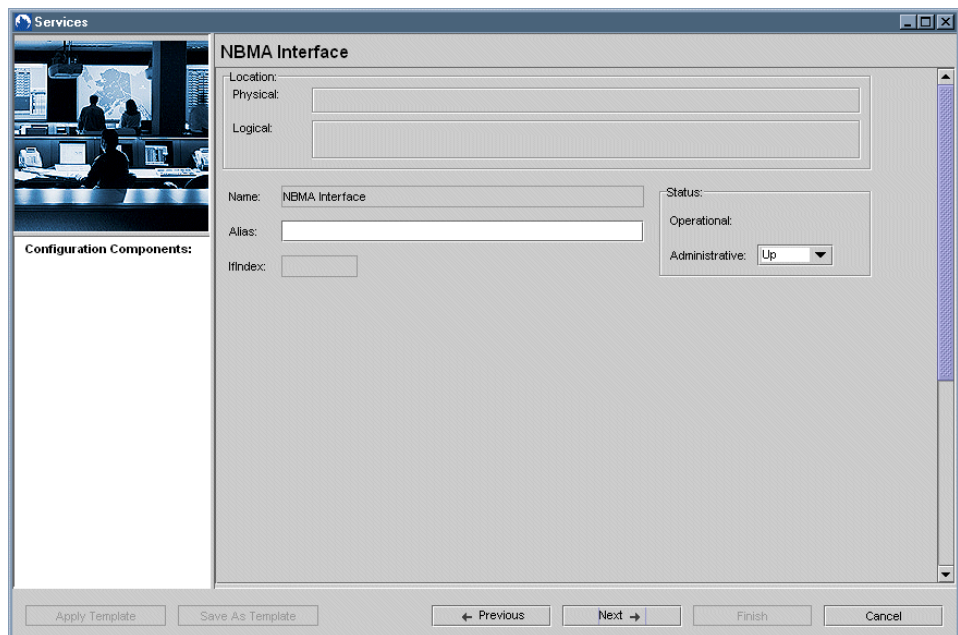

- Set the NBMA interface parameters.

**Table 45: NBMA Interface Parameters**

Parameter	Description
Name	Identifies the interface; generated automatically
Alias	Description of the interface; 0–15 characters; default: blank
IfIndex	Identifies the interface on the particular line interface; generated automatically
Operational	Current operational status of the interface
Administrative	Desired status of the interface: Up/Down; default: Up

- Click Next.

The Number of ATM Circuits dialog box appears.

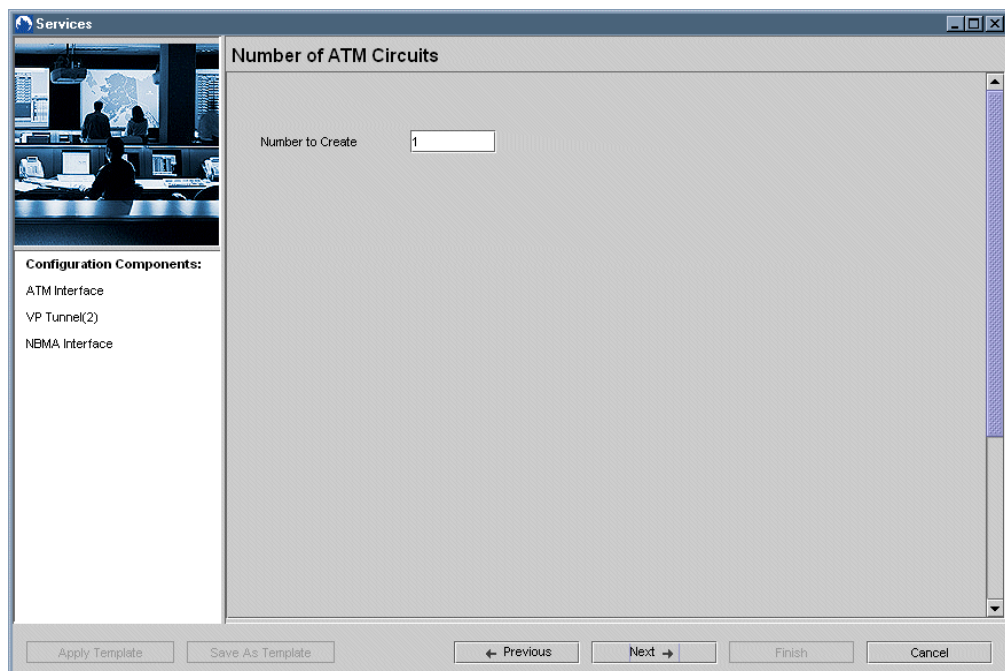

- Set the number of circuits, and click Next.

The ATM Circuit dialog box appears.

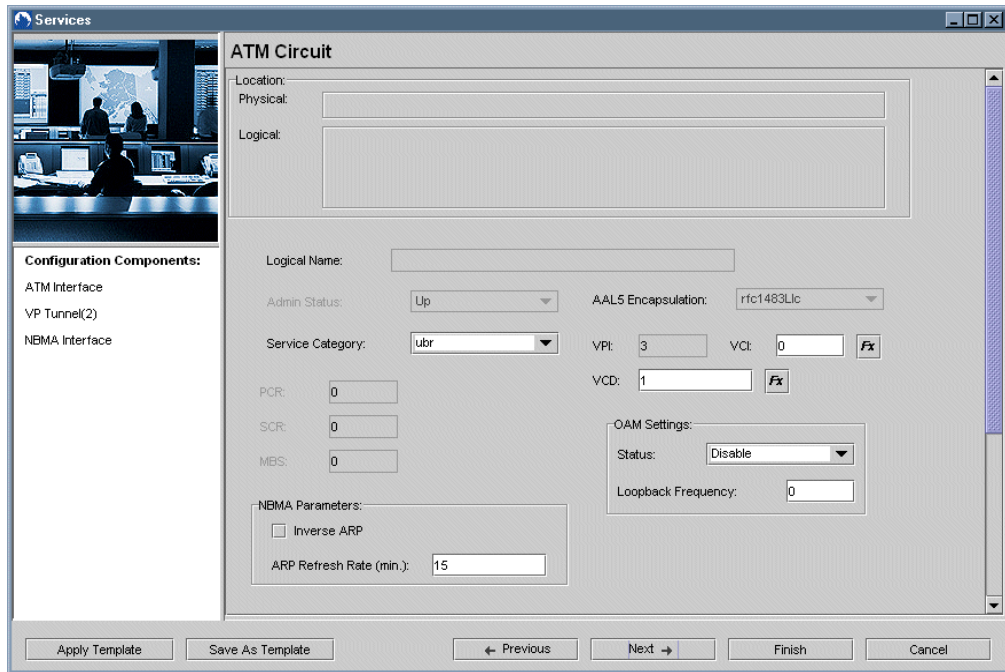

7. Set the ATM circuit's parameters. See Table 44.
8. Click Next.

The Number of IP Addresses dialog box appears.

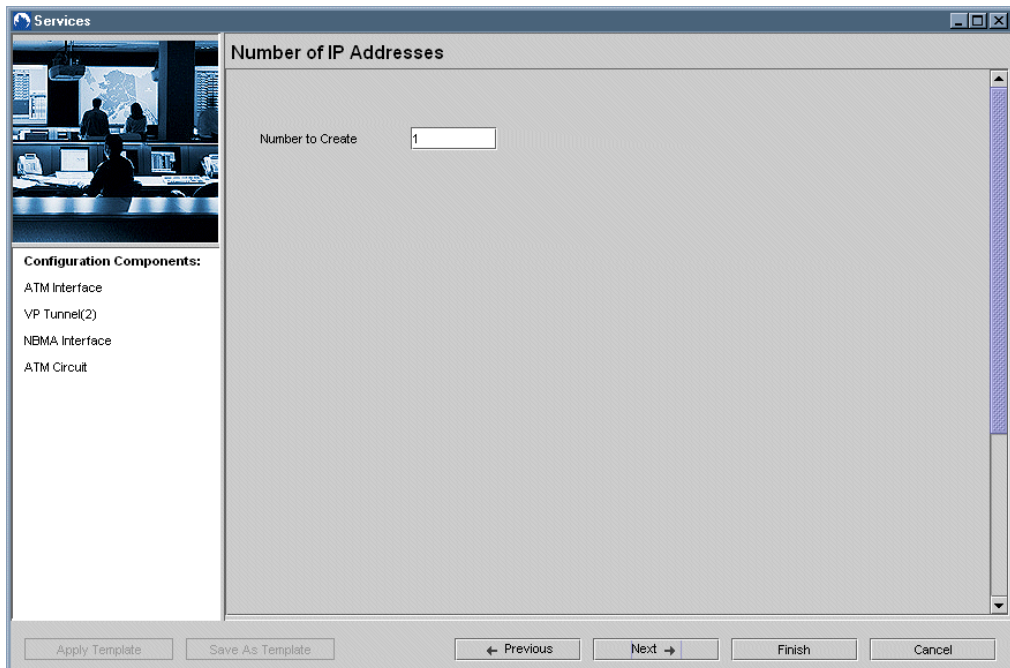

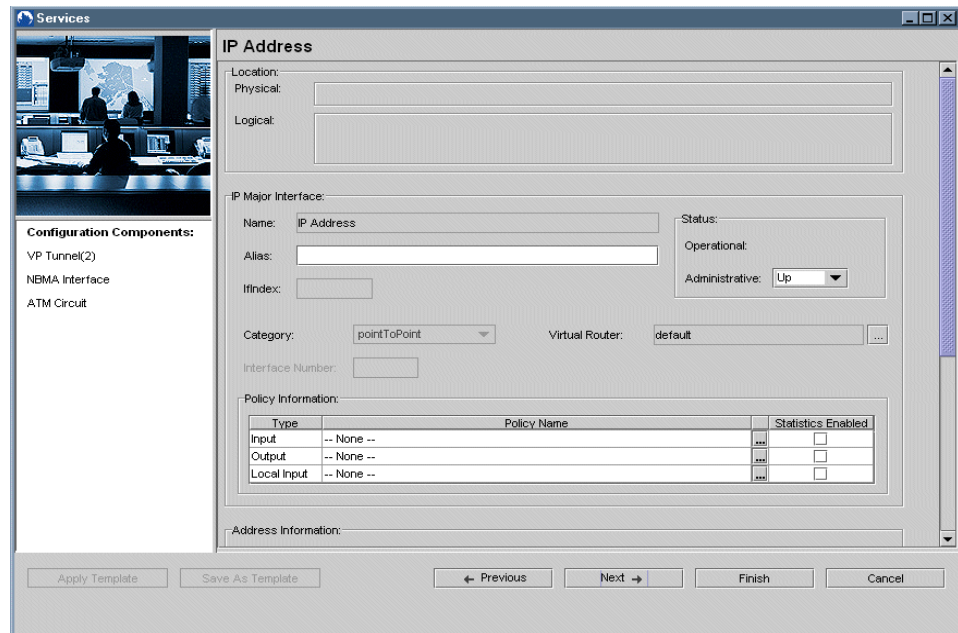

- Set the number of addresses you want, and click Next.

The IP Address dialog box appears.



- Set the IP address parameters. See Table 46.

**Table 46: IP Address Parameters**

Parameter	Description
<b>IP Major Interface</b>	
Name	Identifies the interface; generated automatically
Alias	Description of the interface; 0–15 characters; default: blank
IfIndex	Identifies the interface on the particular line interface; generated automatically
Operational	Current operational status of the interface
Administrative	Desired status of the interface: Up/Down; default: Up
Category	You can select only a point-to-point connection.
Virtual Router	Select the virtual router with which you are associating the IP address and IP interface. Each E-series router always has a default virtual router. In addition to the default router, you may have created other virtual routers. You can display a list of all the available virtual routers by clicking  next to the default router's name. The Associate Virtual Router list appears. From the list, select the virtual router with which you want to associate the IP interface you are creating.
Policy Information	You can associate an existing policy with each of the policy types by clicking  .

**Table 46: IP Address Parameters (continued)**

Parameter	Description
<b>Address Information</b>	
IP Address	A 32-bit number consisting of a network number and a host number; available only when Numbered address type is selected
Address Type	<p>Numbered (default): You can create multiple secondary IP addresses for a single IP interface (except on bridged IP).</p> <p>UnNumbered: There can be only one UnNumbered address on an IP interface.</p> <p>If you select UnNumbered, the Select Interface Index button becomes active. Click this button to display the Select IP Interface dialog box, which allows you to select an Interface Index for the UnNumbered IP address.</p> <p>Unnumbered interfaces are often used in point-to-point connections.</p>
Net Mask	<p>You can set a nondefault value only when you create the IP address. The default value is 255.255.255.0. You cannot modify this parameter later.</p> <p>For an unnumbered IP address, the value for the mask is 255.255.255.255. You cannot edit this value.</p> <p>Within a virtual router, the subnet part of the IP address must be unique in relation to the other addresses on the router.</p>
MTU	Maximum transmission unit. Assigns the MTU size in the range 0–65535. The default value is 0, which means the size is limited by the underlying layer.
UnNumbered Loop Interface Index	<p>Takes the <i>ifindex</i> value of another IP loopback interface with Category set as a loopback.</p> <p>Available only when UnNumbered is selected as address type.</p>

11. Click Next.

The Summary dialog box appears. It lists all the components that you configured.

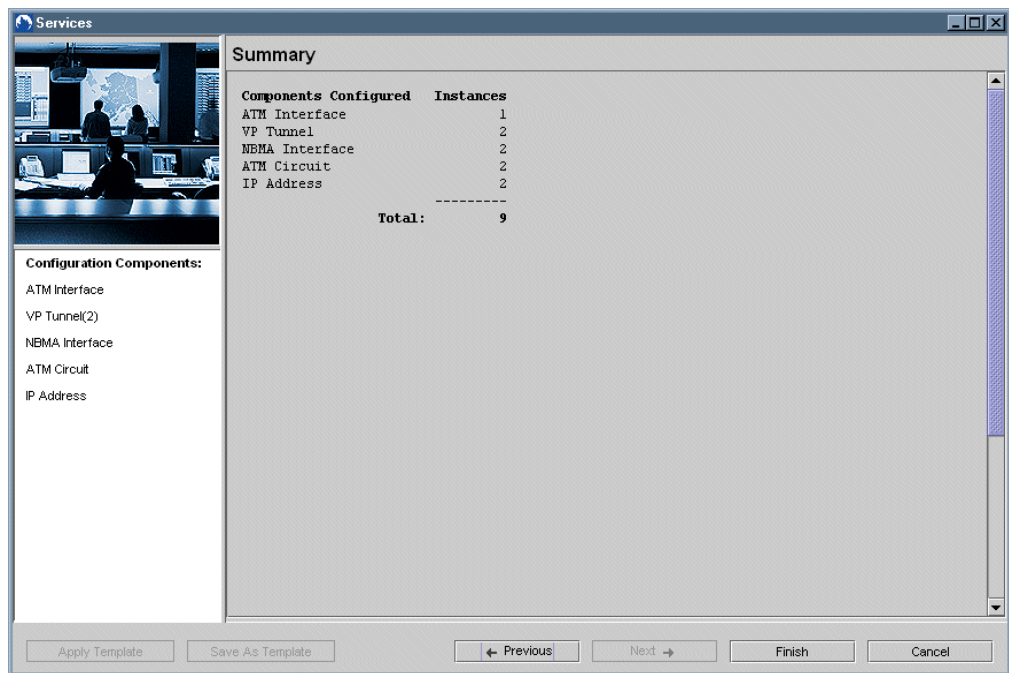

12. To save, click Finish.

## Selecting a Service Type

The NMC-RX application provides several options for the IP over ATM service. These options are referred to as service types. Your choice of a service type determines the rest of the protocol stack for the IP over ATM service.

1. In the Type of Sub Interface dialog box, select ATM Sub Interface, and navigate to the Service Type dialog box. See Figure 6 on page 128.

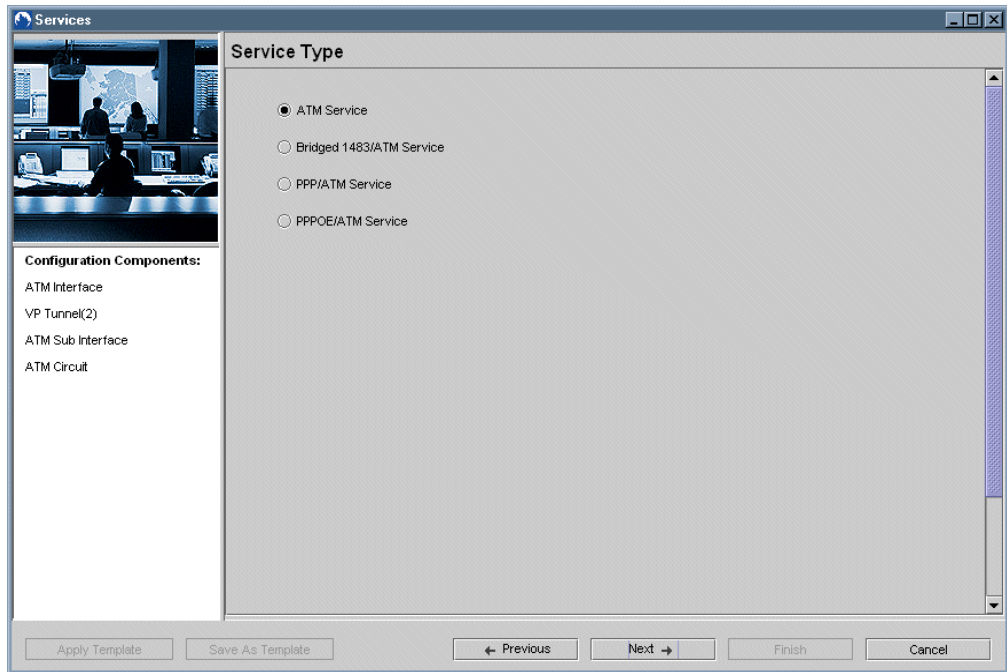

2. Select the service type you want to create.

If you select ATM Service, go to *Creating ATM Service Type*.

If you select Bridged 1483/ATM Service, go to *Creating Bridged 1483/ATM Service Type*.

If you select PPP/ATM Service, go to *Creating PPP/ATM Service Type*.

If you select PPPOE/ATM Service, go to *Creating PPPOE/ATM Service Type*.

## Creating ATM Service Type

---

To create the ATM service type:

1. In the Service Type dialog box, select ATM Service, and click Next.

The Number of IP Addresses dialog box appears.

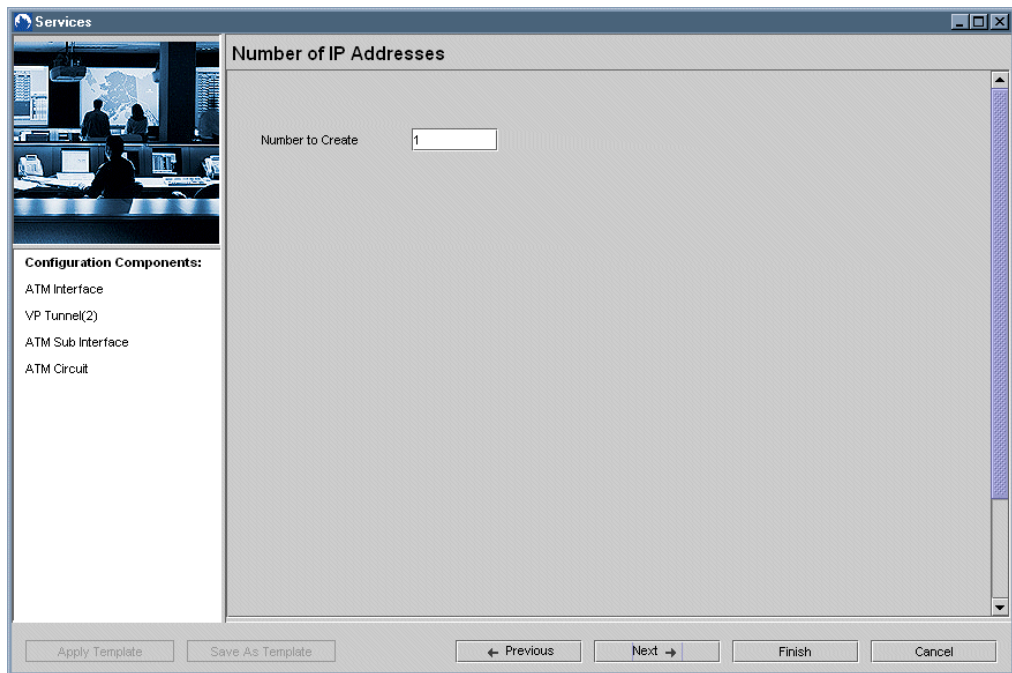

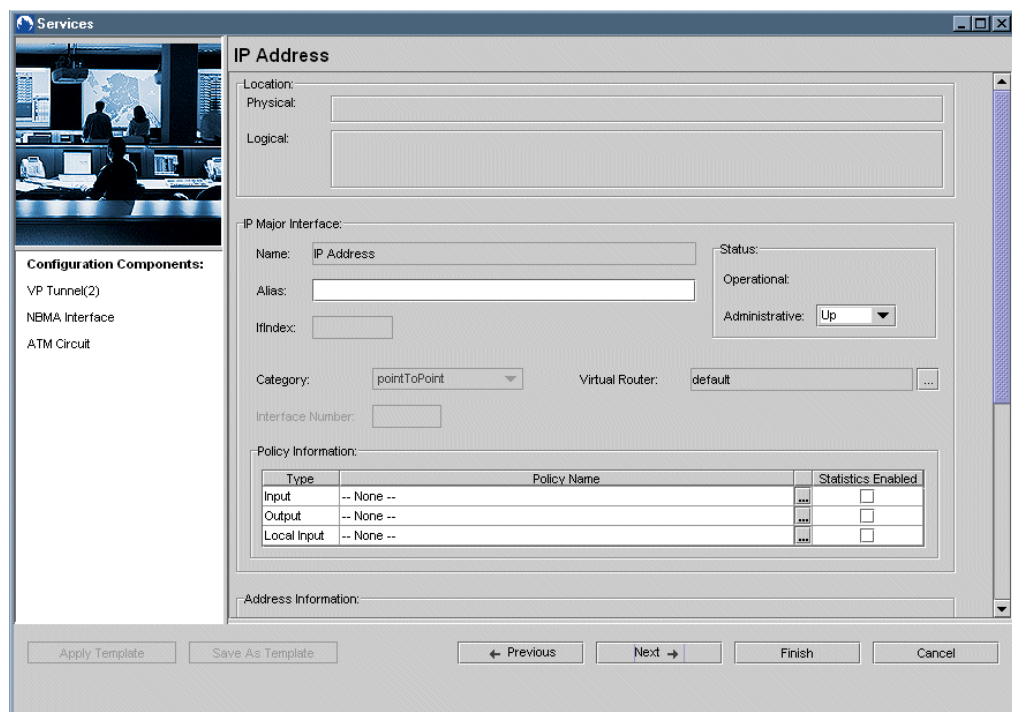

2. In the Number to Create text box, enter the number of IP addresses you want to create, and click Next.

The IP Address dialog box appears.



3. Set the IP address parameters. See Table 46.

Several of the parameters are supported by related dialog boxes that you access by clicking either  or . These related dialog boxes allow you to select parameter settings and ranges.



**NOTE:** The IP address you created is the IP address of the ATM subinterface.

4. Click Next to review a summary of the ATM Service configuration components.

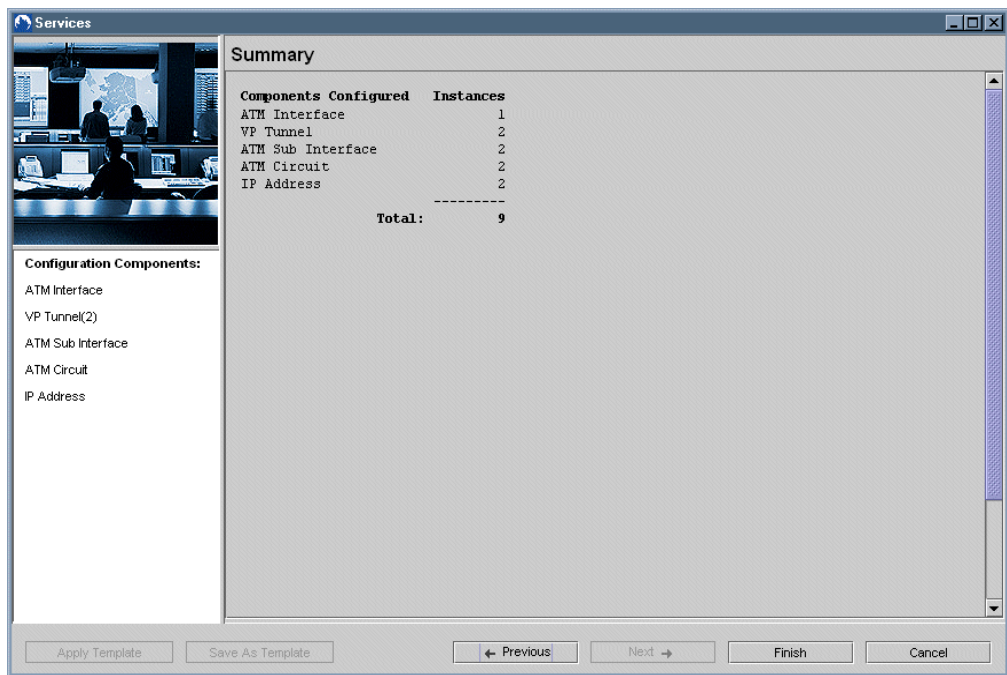

5. To save the ATM service, click Finish.

The following Progress window appears, indicating the progress in creating the instances of each component.

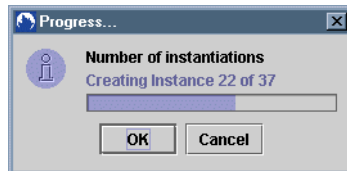

## Creating Bridged 1483/ATM Service Type

The bridged 1483/ATM service builds on the ATM service protocol stack.

To create the bridged 1483/ATM service type:

1. When the Service Type dialog box appears, select Bridged 1483/ATM Service.

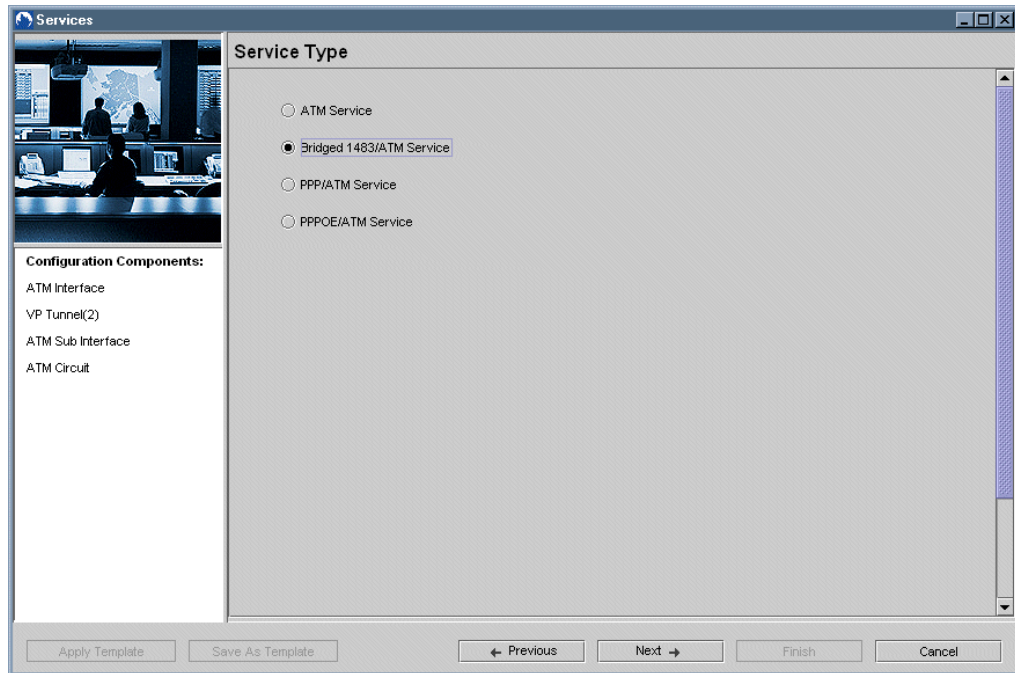

2. Click Next.

The Bridged 1483 dialog box appears.

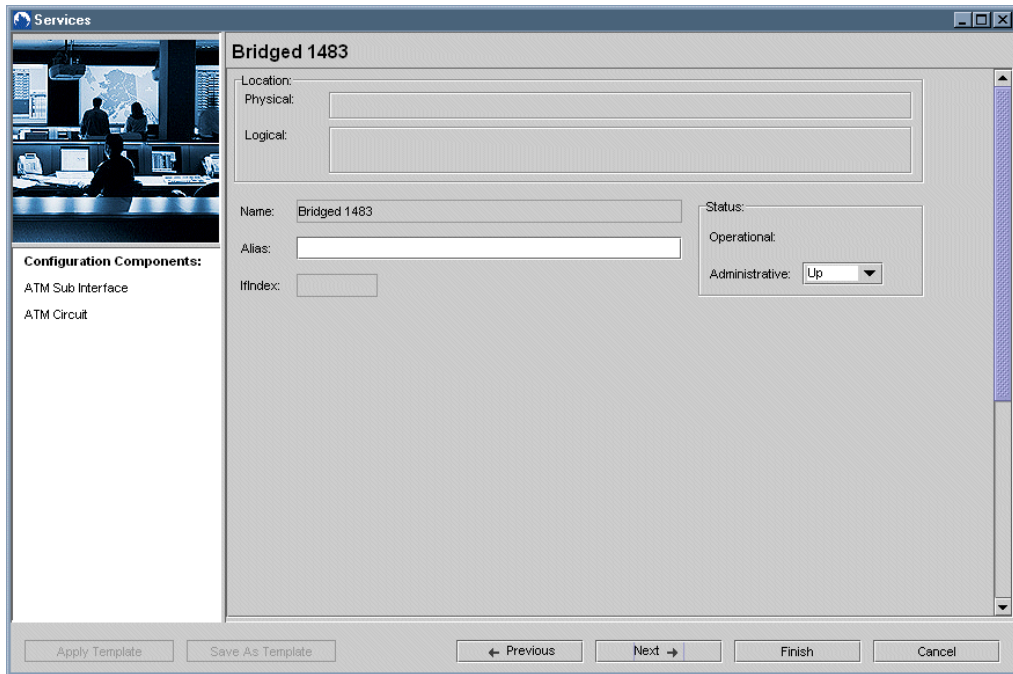

3. Set the Bridged 1483 parameters. See Table 47.

**Table 47: Bridged 1483 Parameters**

Parameter	Description
Name	Identifies the interface; generated automatically
Alias	Description of the interface; 0–15 characters; default: blank
IfIndex	Identifies the interface on the particular line interface; generated automatically
Operational	Current operational status of the interface
Administrative	Desired status of the interface: Up/Down; default: Up

4. Click Next.

The IP Stack Decision Point dialog box appears.

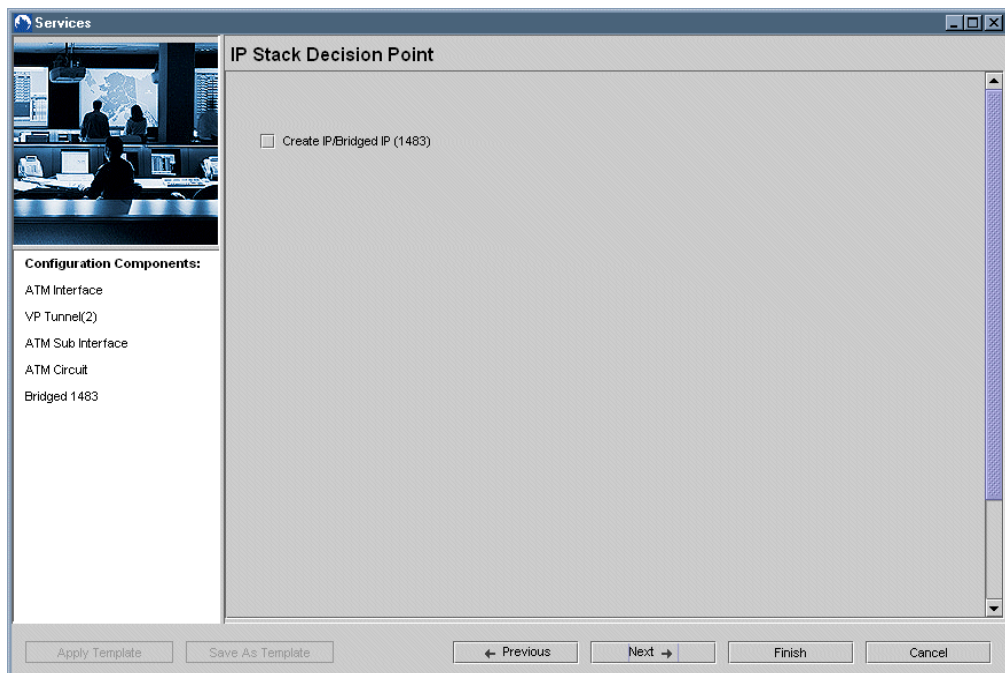

The bridged 1483 service has several of these decision points. If you do not select the check box in these dialog boxes and click Next, you will move through these decision points to Summary and Finish.

If you select the check boxes, you will continue through protocol stacks for each of the decision points. This section will take you through each of these stacks.

5. Select Create IP/Bridged IP (1483), and click Next.

The IP Address dialog box appears.

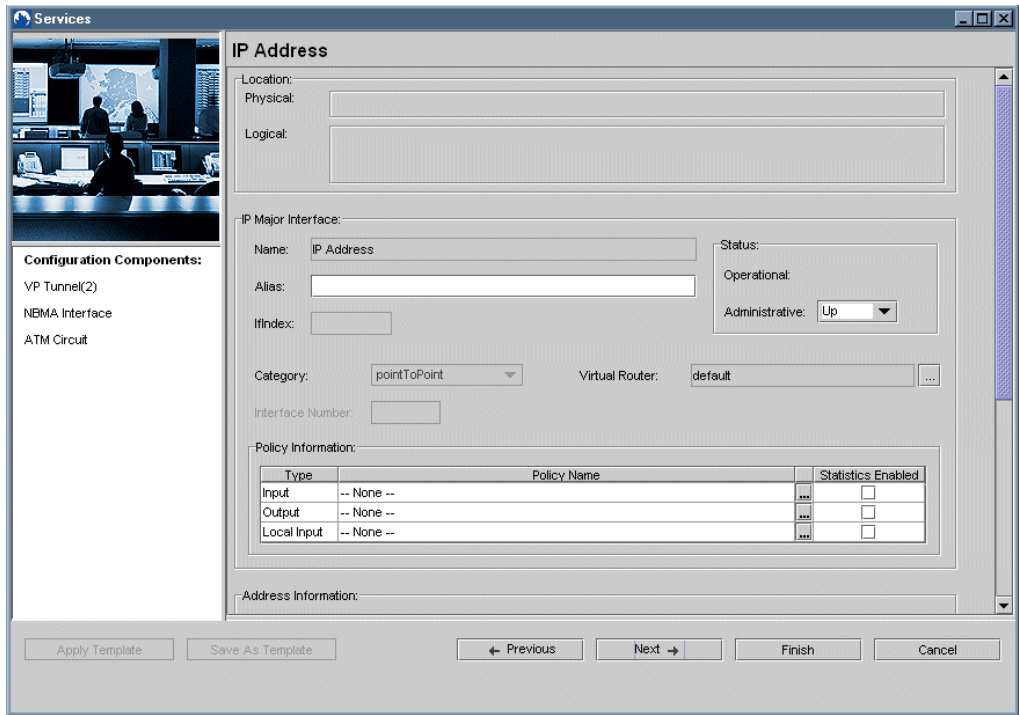

6. Set the IP address parameters (if they are not already set). See Table 46.



**NOTE:** The IP address you created is the IP address of the bridged 1483 interface.

7. Click Next.

The PPPoE Stack Decision Point dialog box appears.

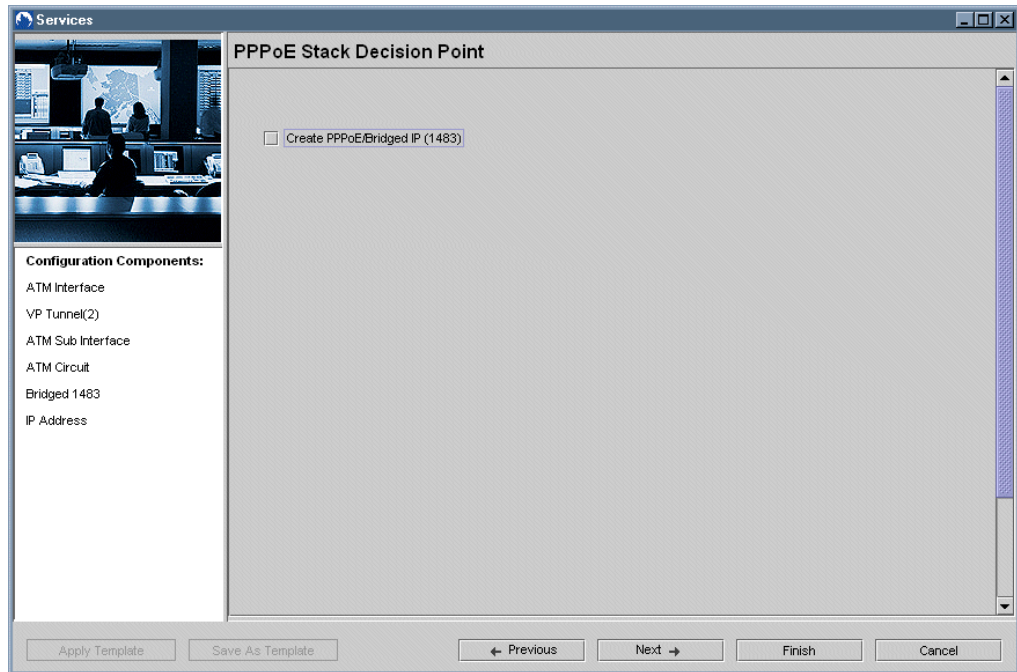

8. Select Create PPPoE/Bridged IP (1483), and click Next.

The (Hybrid) PPPoE Interface over Bridged IP (1483) dialog box appears.

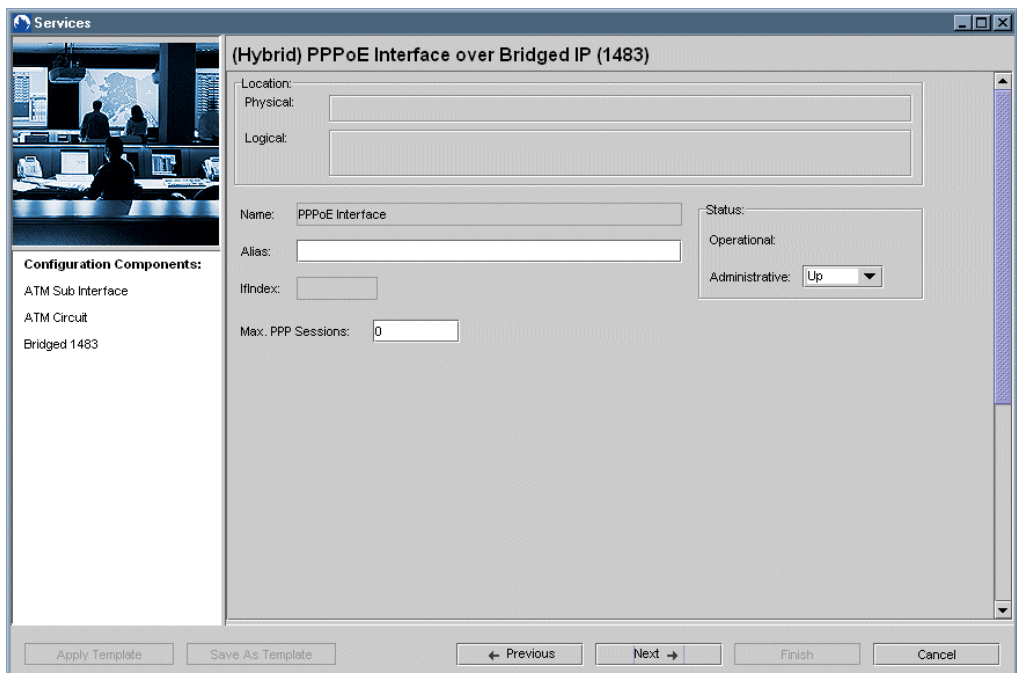

9. Set the PPPoE interface parameters.

**Table 48: PPPoE Interface Parameters**

Parameter	Description
Name	Identifies the interface; generated automatically
Alias	Description of the interface; 0–15 characters; default: blank
IfIndex	Identifies the interface on the particular line interface; generated automatically
Operational	Current operational status of the interface
Administrative	Desired status of the interface: Up/Down; default: Up
Max PPP Sessions	Range 0–0494

10. Click Next.

The Number of PPPoE Sub Interfaces dialog box appears. From this point through the IP Address dialog box, the steps are the same as creating PPPoE and PPP service types. See *Creating PPPoE/ATM Service Type* on page 163 and *Creating PPP/ATM Service Type* on page 158.

11. After you set the parameters in the IP Address dialog box, click Next.

12. Select Create CBF/Bridged IP (1483), and click Next.

The CBF Stack Decision Point dialog box appears.

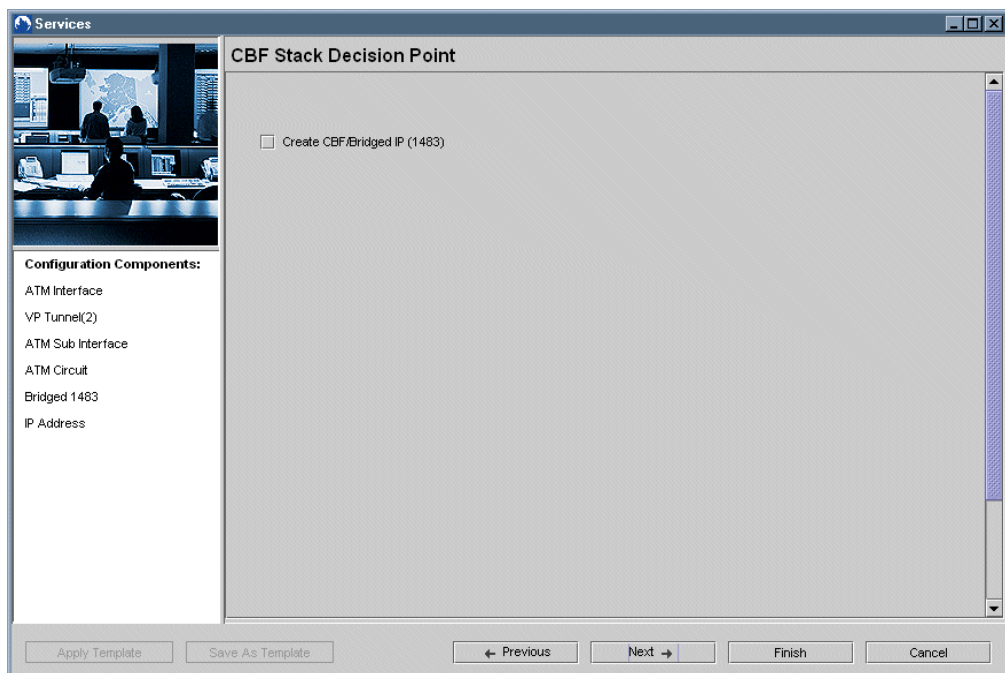

13. Select Create CBF/Bridged IP (1483), and click Next.

The (Hybrid) CBF Interface over Bridged IP (1483) dialog box appears.

The screenshot shows a configuration window titled "Services" with a sub-window titled "(Hybrid) CBF Interface over Bridged IP (1483)". On the left, there is a "Configuration Components" list with the following items: ATM Sub Interface, ATM Circuit, Bridged 1483, IP Address, (Hybrid) PPPoE Interface, PPPoE Sub Interface, PPP Interface, and IP Address. The main configuration area contains the following fields:

- Location: Physical: [Empty text box]
- Location: Logical: [Empty text box]
- Name: (Hybrid) CBF Interface over Bridged IP (1483)
- Ifindex: [Empty text box]
- Status: Operational: [Empty text box]
- Status: Administrative: Up (dropdown menu)

At the bottom of the dialog, there are buttons for "Apply Template", "Save As Template", "Previous", "Next", "Finish", and "Cancel".

14. Set the CBF interface parameters.

**Table 49: CBF Interface Parameters**

Parameter	Description
Name	Identifies the interface; generated automatically
Ifindex	Identifies the interface on the particular line interface; generated automatically
Operational	Current operational status of the interface
Administrative	Desired status of the interface: Up/Down; default: Up

15. Click Next to review a summary of the bridged 1483 service configuration.

The Summary appears.

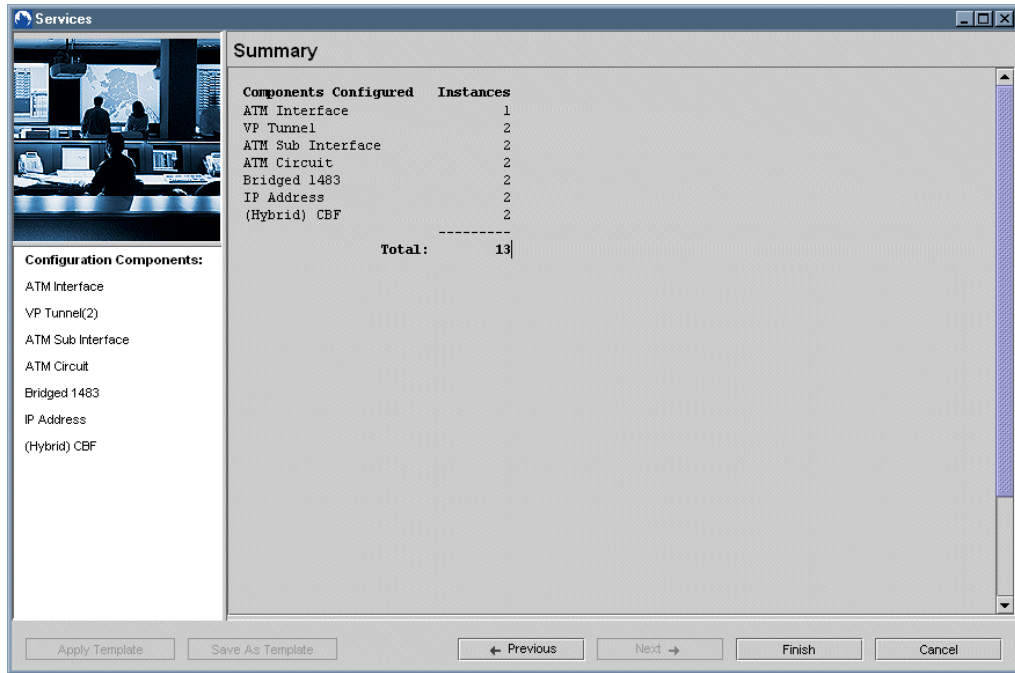

16. Click Finish.

## Creating PPP/ATM Service Type

The PPP/ATM service builds on the ATM protocol stack.

To create the PPP/ATM service type:

1. When the Service Type dialog box appears, select PPP/ATM Service.

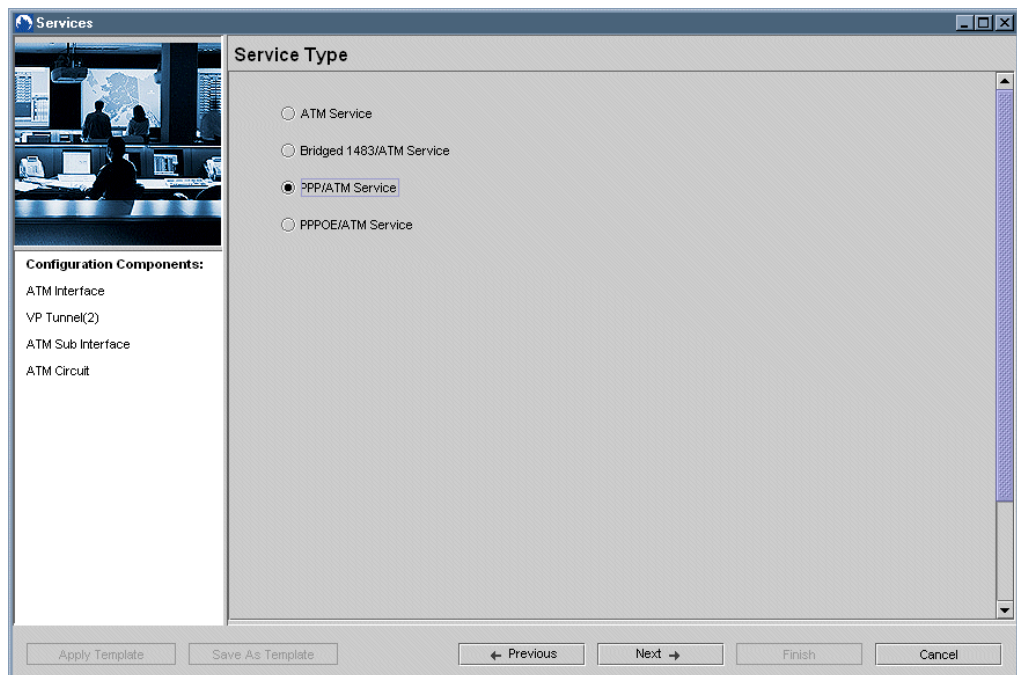

2. Click Next.

The PPP Interface dialog box appears.

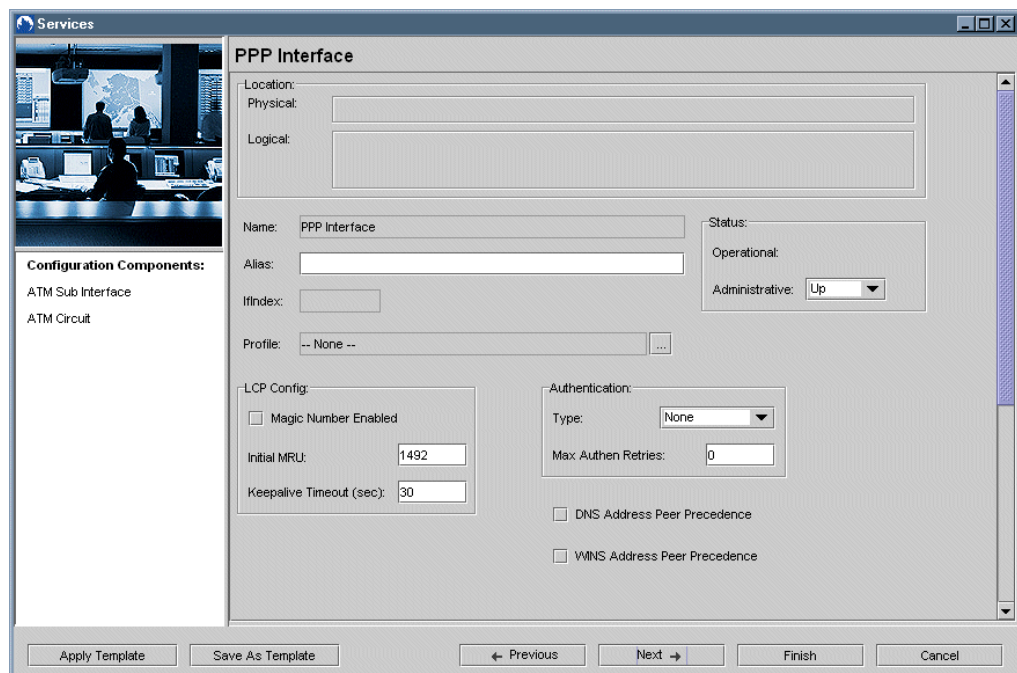

3. Set the PPP interface parameters. See Table 50.

**Table 50: PPP Interface Parameters**

Parameter	Description
Name	Identifies the interface; generated automatically
Alias	Description of the interface; 0–15 characters; default: blank
IfIndex	Identifies the interface on the particular line interface; generated automatically
Operational	Current operational status of the interface
Administrative	Desired status of the interface: Up/Down; default: Up
Profile	Profile that you want to associate with this interface. Click  to open the Associate Profile dialog box.
DNS Address Peer Precedence	Indicates which value takes precedence when the E-series router and the PPP peer system have the primary and secondary Domain Name System (DNS) name server addresses configured with different values.
WINS Address Peer Precedence	Indicates which value takes precedence when the E-series router and the PPP peer system have the primary and secondary Windows Internet Name System (WINS) name server addresses configured with different values.
<b>LCP Config</b>	
Magic Number Enabled	Randomly generated number used to identify one end of a point-to-point connection. LCP (Link Control Protocol) magic number support is available on all serial interfaces. PPP always attempts to negotiate for magic numbers, which are used to detect looped-back lines. The router might shut down a link if it detects a loop.
Initial MRU	LCP on maximum receive unit must be within the following ranges: POS interface—64–4466 DS0 bundle—64–1596 ATM subinterface—64–9178 PPPoE subinterface—64–1492
Keepalive Timeout (sec)	Keepalive tracks the status of the connection. The timeout period is set in the range 30–300 seconds for high-density mode (for example, when PPP is layered over PPPoE or ATM subinterfaces) and 10–300 seconds for low-density mode (when PPP is layered over POS or a DS0 bundle). The default is 30 seconds.
<b>Authentication</b>	
Type	Authentication method chosen to verify access to the interface. Choose from the drop-down list. None—No authentication method specified pap—Specifies PAP (Password Authentication Protocol) as primary authentication protocol chap—Specifies CHAP (Challenge Handshake Authentication Protocol) as primary authentication protocol papChap—Specifies PAP as primary authentication protocol and CHAP as the alternate chapPap—Specifies CHAP as primary authentication protocol and PAP as the alternate
Max Authen Retries	Number of times a user can fail to enter the correct login information (username and password) to gain access

4. Click Next.

The Number of IP Addresses dialog box appears.

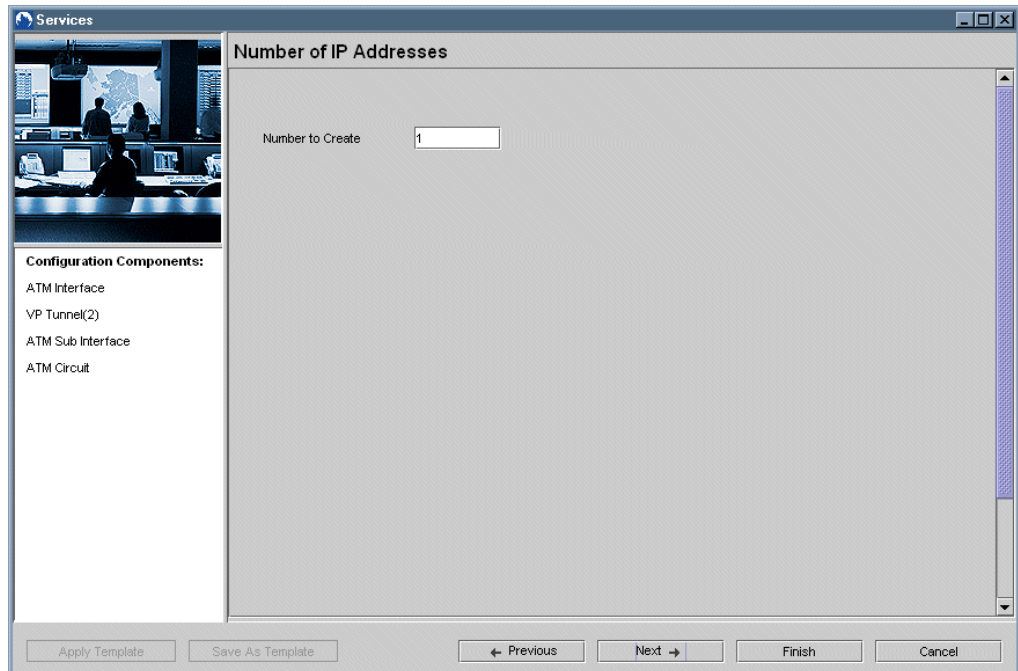

5. Enter the number of IP addresses you want to create.
6. Click Next.

The IP Address dialog box appears.

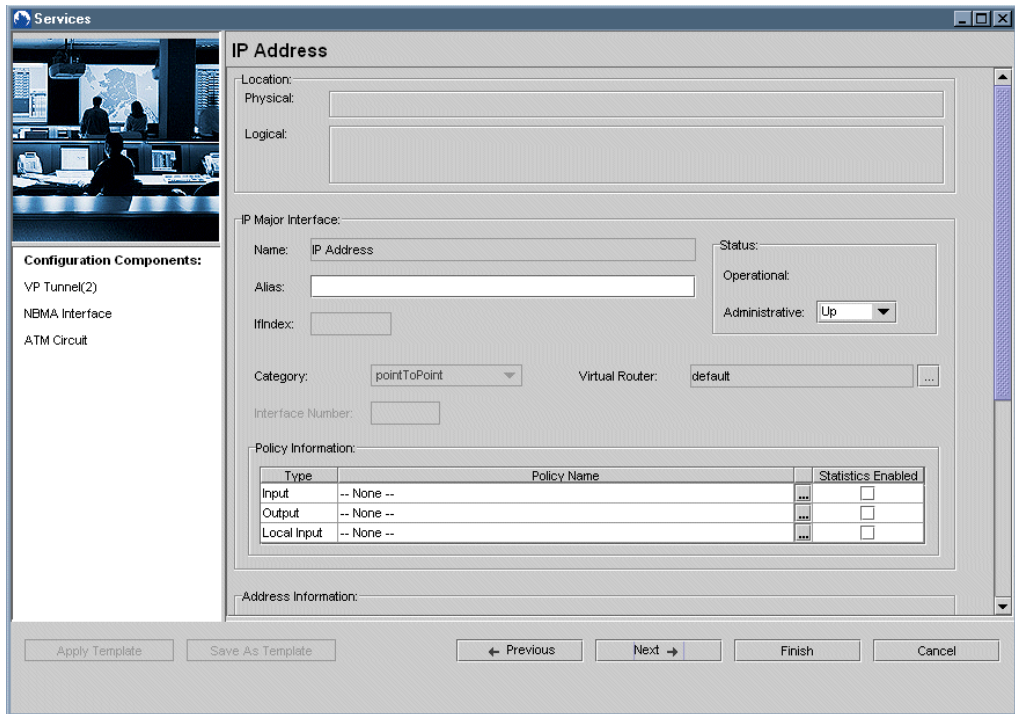

7. Set the IP address parameters. See Table 46 on page 145.

Several of the parameters are supported by related dialog boxes that you access by clicking either  or .



**NOTE:** The IP address you created is the IP address of the ATM subinterface.

8. Click Next.

A summary of the PPP service configuration appears.

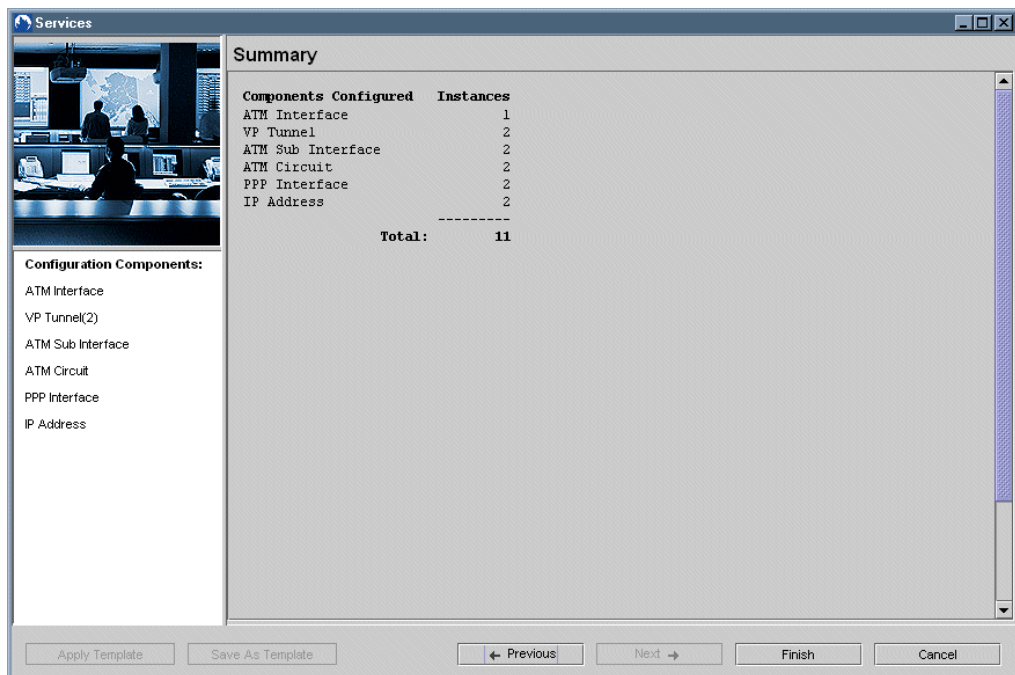

9. Click Finish.

## Creating PPPoE/ATM Service Type

The PPPoE/ATM service builds on the ATM service's protocol stack.

To create the PPPoE/ATM service type:

1. When the Service Type dialog box appears, select PPPoE/ATM Service.

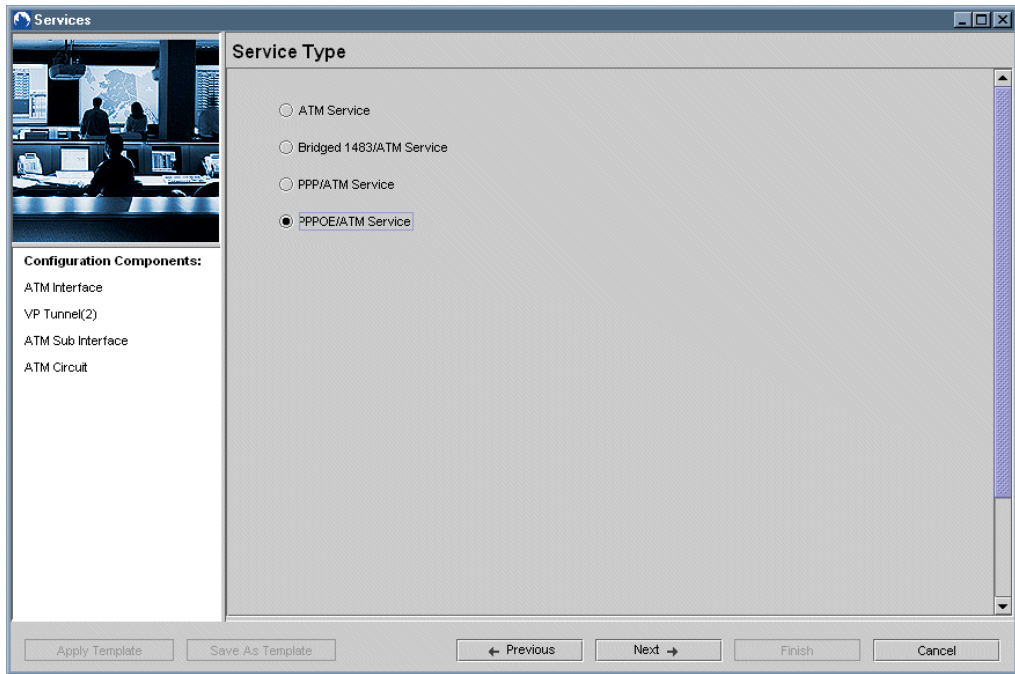

2. Click Next.

The PPPoE Interface dialog box appears.

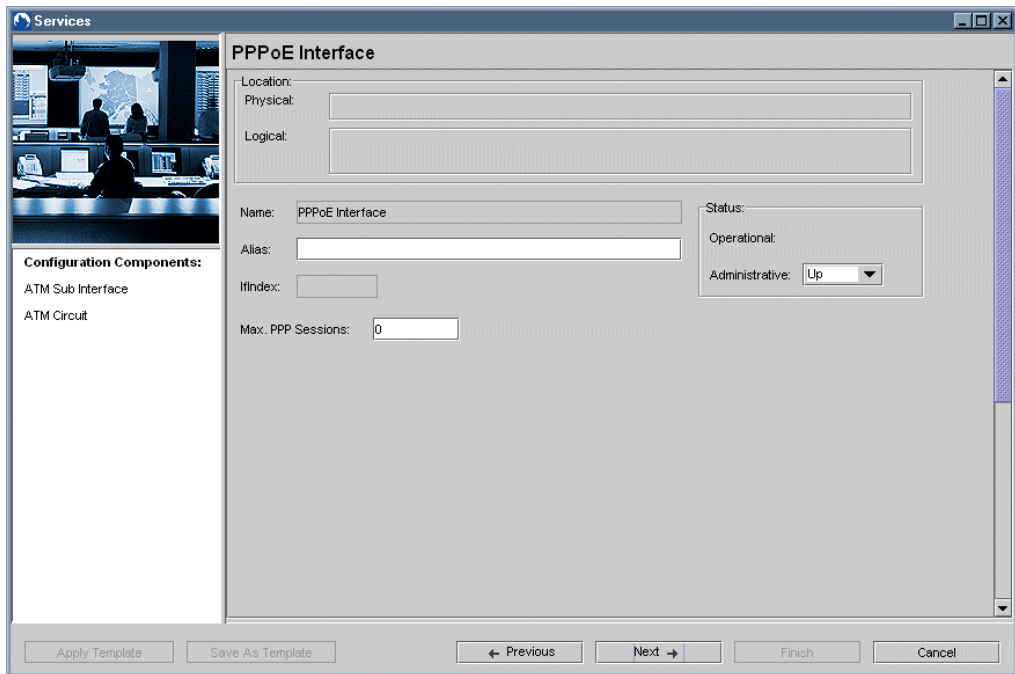

3. Set the PPPoE interface parameters.

**Table 51: PPPoE Interface Parameters**

Parameter	Description
Name	Identifies the interface; generated automatically
Alias	Description of the interface; 0–15 characters; default: blank
Ifindex	Identifies the interface on the particular line interface; generated automatically
Operational	Current operational status of the interface
Administrative	Desired status of the interface: Up/Down; default: Up
Max PPP Sessions	Range 0–0494

4. Click Next.

The Number of PPPoE Sub Interfaces dialog box appears.

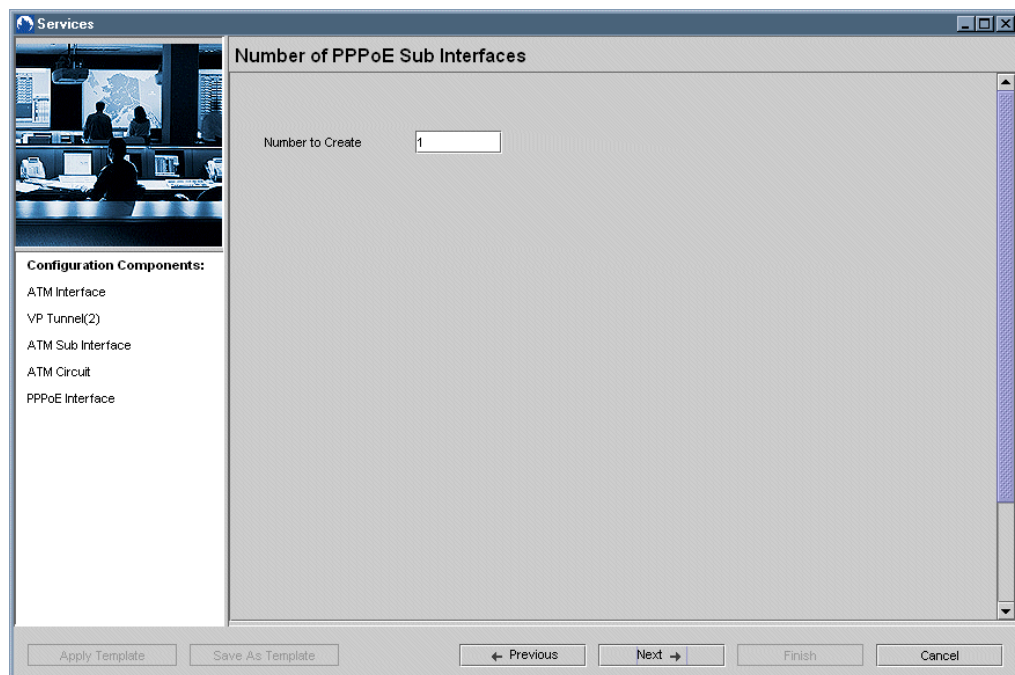

5. Enter the number of subinterfaces you want to create, and click Next.

The PPPoE Sub Interface dialog box appears.

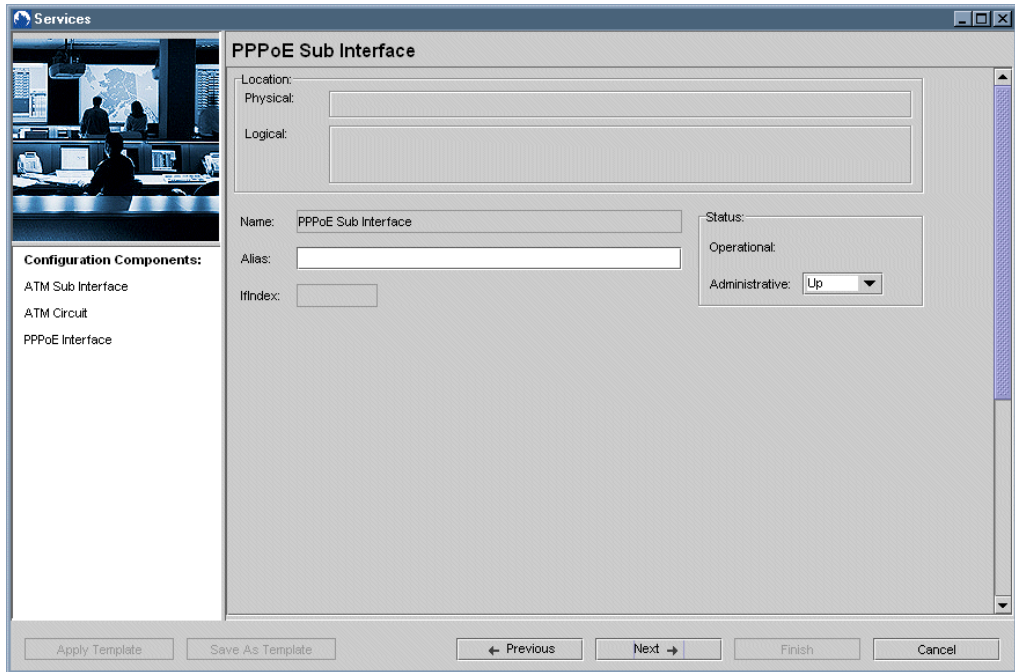

6. Set the PPPoE subinterface parameters.

**Table 52: PPPoE Subinterface Parameters**

Parameter	Description
Name	Identifies the interface; generated automatically
Alias	Description of the interface; 0–15 characters; default: blank
IfIndex	Identifies the interface on the particular line interface; generated automatically
Operational	Current operational status of the interface
Administrative	Desired status of the interface: Up/Down; default: Up

7. Click Next.

The PPP Interface dialog box appears. From this point, the process for creating the PPPoE service is the same as for the PPP service. See *Creating PPP/ATM Service Type* on page 158.

## Related Dialog Box

The  button to the right of a text box allows you to select existing objects (rather than create new ones).

**Select Template Pak** The Select Template Pak dialog box allows you select an existing template rather than having to create a new one.

1. In the Template Settings dialog box, click the  button to the right of the Template Pak text box.

The Select Template Pak dialog box appears.

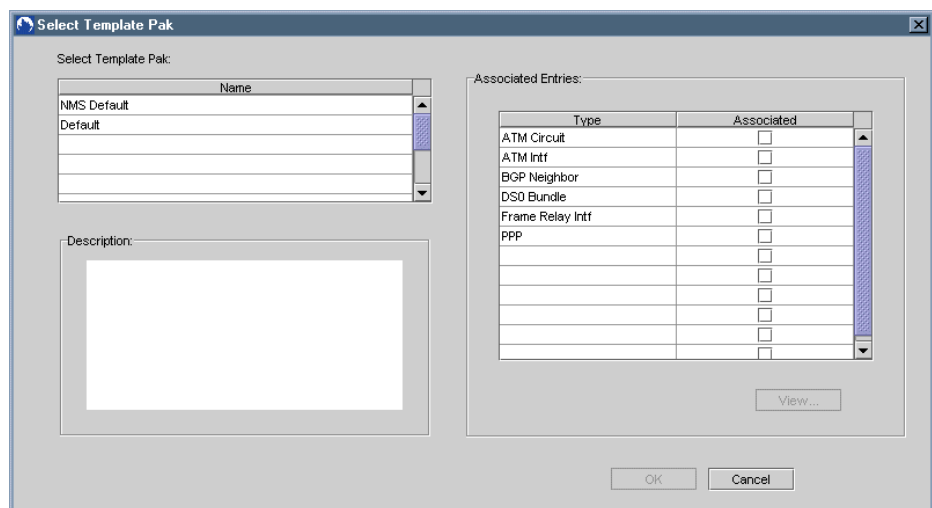

2. Select a template from the Select Template Pak list.
3. To view the entries in the Associated Entries group box, select the entry and click the View button.
4. When you are satisfied with your template pak selection, click OK.

