

Configuring Channelized OC Modules

10

The NMC-RX application supports creating and configuring DS3 and DS1 interfaces on cOCx/STMx channelized optical carrier (OC) line modules.

Topic	Page
Overview	10-1
Configuration Tasks	10-3
Configuring Modules	10-4
Configuring a Line Interface	10-5
Configuring SONET Paths	10-7
Configuring DS3 Interfaces	10-10

Overview

OC modules provide high-speed communications between E-series routers and core routers in an ATM network. There are two versions of channelized OC (cOC) modules that can be configured with the NMC-RX application: cOC3 and cOC12.

In E-series devices, OC line modules pair with I/O modules to provide particular capabilities and connections. For more information on channelized OC modules, see Table 10-1 and the *E-Series Physical Layer Configuration Guide*.

Table 10-1 Channelized OC line modules and I/O modules

Line Module	I/O Module	Description	NMC-RX Software Reference Name
cOCx/STMx	cOC3/STM1	4-port, channelized OC3/STM1 for Frame Relay	COC3 FRAME-4 port
	cOC12/STM4	1-port, channelized OC12/STM4 for Frame Relay	COC12 FRAME-1 port

DS3 and DS1 interfaces are not automatically created on cOCx modules – you must manually create them – and can be stacked in multiple ways (see Figure 10-1).

You can designate a cOCx line module for TI or E1 connections. Mapping to T1 or E1 does not have any effect on the device; however, the operation mode of the DS1 interfaces that get created on the line module are set to T1 or E1.

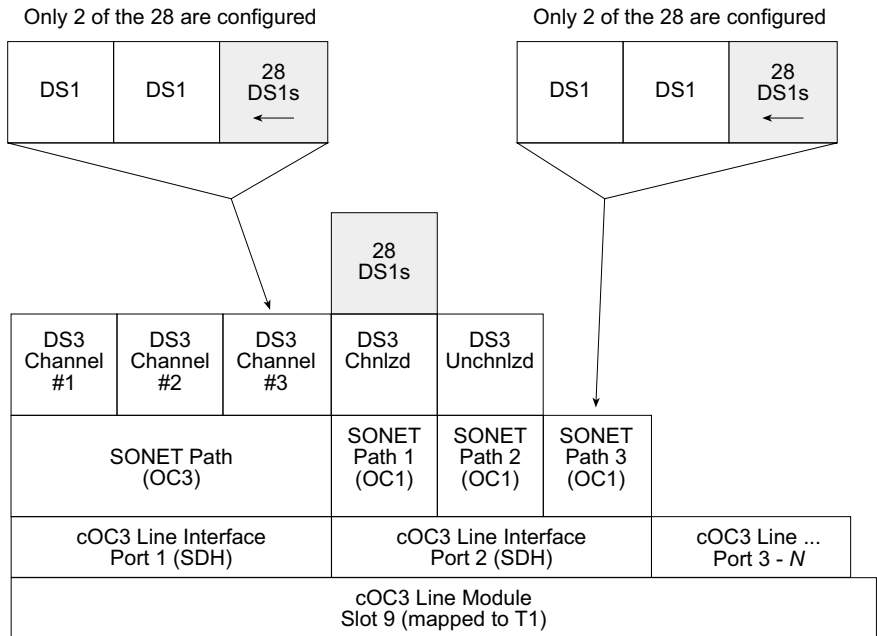

Figure 10-1 cOC3 line module stacking example

- Example 1** In Figure 10-1, ports 1 and 2 have cOC3 line interfaces configured with SDH mode. In SDH mode, SONET paths of OC1/STM0 or OC3/STM1 speed can be created. All OC3-speed SONET paths have three DS3 channels that indicate the DS3 channel number of the DS1 interfaces that are created on them. On OC1-speed SONET paths, the DS3 channel is always 1. There are no DS3 interfaces on port 1 in this example because DS3 interfaces cannot be created on OC3-speed SONET paths.
- Example 2** Port 2 has an OC1-speed SONET path on a cOC3 line interface in SDH mode. SONET path 1 has a channelized DS3 interface which has 28 DS1 interfaces that were automatically generated when the DS3 interface was created. There are 28 DS1 interfaces because the card is mapped to T1 operation mode. If the card were mapped to an E1 line module, DS3 interfaces would not be able to be created.
- Example 3** SONET path 2 on port 2 has an unchannelized DS3 interface with no DS1 interfaces (DS1 interfaces cannot exist on unchannelized DS3 interfaces). Instead, Cisco HDLC, Frame Relay, and PPP can be created directly on unchannelized DS3 interfaces.

Configuration Tasks

To configure a channelized OC module, complete the following tasks:

- 1 Enable or disable the line module.
- 2 Map the line interface to T1 or E1.
- 3 Set the line interface parameters.
- 4 Configure SONET paths and map DS1 interfaces, if applicable.
- 5 Create DS3 interfaces.

Configuring Modules

You can configure only a module's admin status (enabled or disabled).

To configure a module:

- 1 In the Instance Explorer list, select the module you want to configure.
- 2 Right-click, and click either Map to T1 or Map to E1.

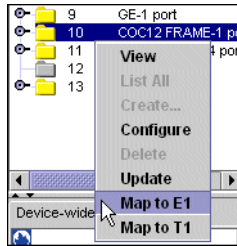

- 3 Right-click again, and click Configure.

The Module Config tab appears in the work area. Note that the operation mode is set to the option you chose in step 2.

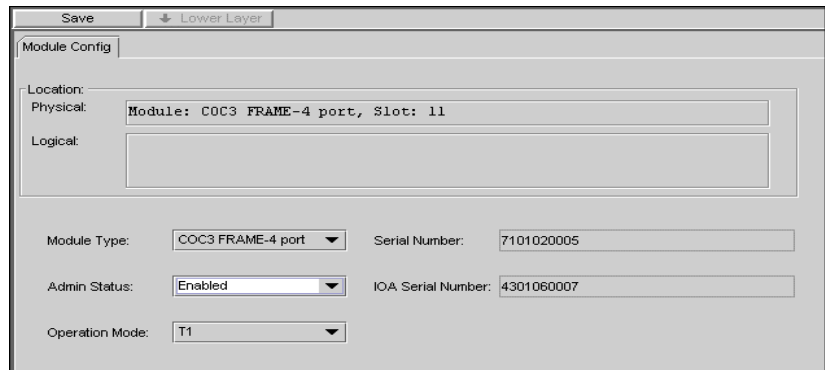

- 4 Set the admin status. See Table 10-2.

Table 10-2 Module configuration parameters

Field	Description
Module Type	The module type (uneditable)
Admin Status	<ul style="list-style-type: none"> Enabled – the module is running Disabled – the module is not in operation
Operation Mode	Displays if module is mapped to a T1 or E1 line module

Table 10-2 Module configuration parameters (continued)

Field	Description
Serial Number	Ten-digit identification number (S/N) on the module's faceplate. This value is automatically retrieved from the device and is uneditable.
IOA Serial Number	Ten-digit identification number (S/N) on the input/output adapter's faceplate. This value is automatically retrieved from the device and is uneditable.

- 5 Click Save.

Configuring a Line Interface

To configure a line interface:

- 1 In the Instance Explorer, select the line interface you want to configure.
- 2 Right-click, and click Configure.

The OC Config tab appears in the work area.



Note: The Sonet Path Speed parameter does not appear for cOC12 line modules.

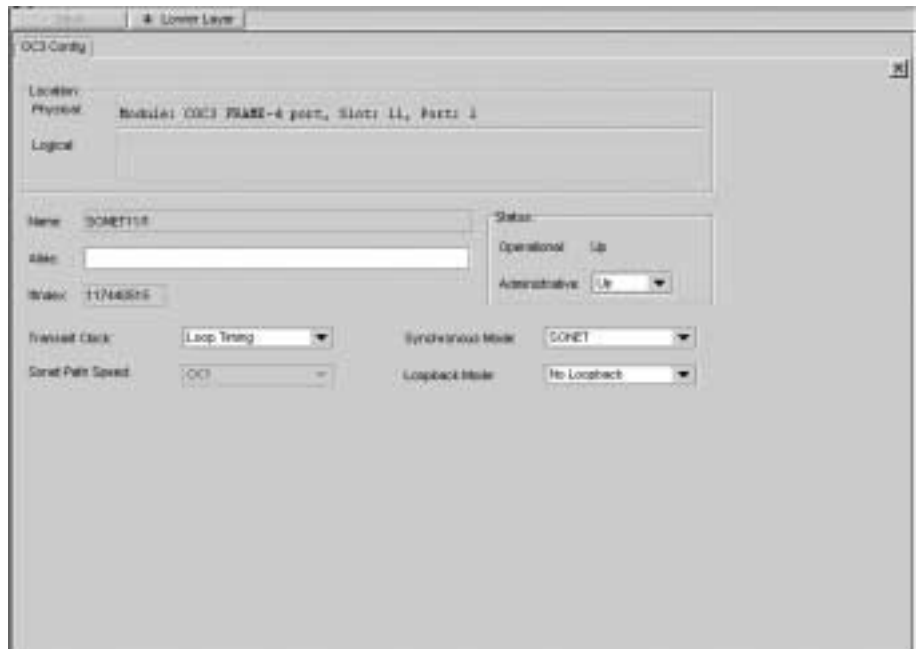

3 Set the line interface parameters. See Table 10-3.

Table 10-3 Line interface parameters

Field	Description
Name	Identifies the interface; generated automatically
Alias	Description of the interface; 0–15 characters; default: blank
IfIndex	Identifies the interface on the particular line interface; generated automatically
Operational	Current operational status of the interface
Administrative	Desired status of the interface: Up/Down; default: Up
Transmit Clock	<ul style="list-style-type: none"> • Loop Timing – device receives its clocking from a network source • Internal Module – device receives its clocking from a network source • Internal Chassis – device receives its clocking from the configured system clock
Sonet Path Speed	<ul style="list-style-type: none"> • Speed for SONET paths generated on the line interface <ul style="list-style-type: none"> › OC3 – creates an OC3 SONET path with three DS3 channels on top of the line interface › OC1 – creates three OC1 paths on top of the line interface › Unspecified – does not allow anything to be created or configured on the interface • Enabled only when SDH is selected for synchronous mode • Disabled if there are any DS3 or DS1 interfaces on the line interface • Not visible for cOC12 line modules
Synchronous Mode	<ul style="list-style-type: none"> • SONET – Synchronous Optical Network <ul style="list-style-type: none"> › disables Sonet Path Speed field and sets to it OC1 • SDH – Synchronous Digital Hierarchy <ul style="list-style-type: none"> › enables Sonet Path Speed field
Loopback Mode	<ul style="list-style-type: none"> • No Loopback – disables loopback mode • Line Loopback – loops the data toward the network; connects the received network signal directly to the transmit network signal line • Internal Loopback – loops the data toward the module's interface; connects the local transmitted signal to the local received signal

4 Click Save.

Configuring SONET Paths

SONET paths can be configured on cOC12 line modules. You can create SONET paths or delete SONET paths from a line interface by using the Configure Sonet Paths dialog box.

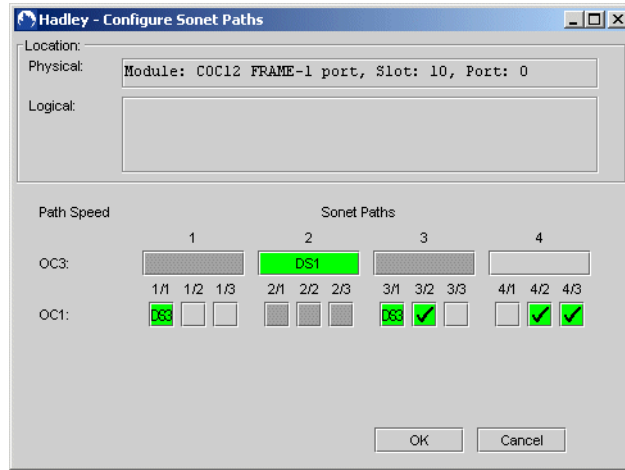

When a cOC12 line interface is in SDH mode, it can contain both OC3- and OC1-speed SONET paths, enabling multiple SONET paths of different speeds to be created.

Each check mark indicates a SONET path that has just been selected, or one that already exists with no stacking other than DS3 channels on it. When a SONET path is selected, any SONET path that is directly above or below is deselected. These SONET paths overlap and cannot exist simultaneously. SONET paths with a DS3 or DS1 interface are labeled DS3 and DS1, respectively, and cannot be deselected. SONET paths that overlap with these SONET paths appear dimmed and cannot be selected.

If the cOC12 line interface is configured with Synchronous Mode set to SONET, OC3-speed SONET paths are not allowed and are disabled in the Configure Sonet Paths dialog box.

For more detailed information on SONET paths, see *E-Series Physical Layer Configuration Guide, Chapter 1, Configuring OCx/STMx Interfaces*.

To configure a SONET path:

- 1 On a cOC12 line module, click a line interface.
- 2 Right-click and click Configure Sonet Paths.

The Configure Sonet Paths dialog box appears.

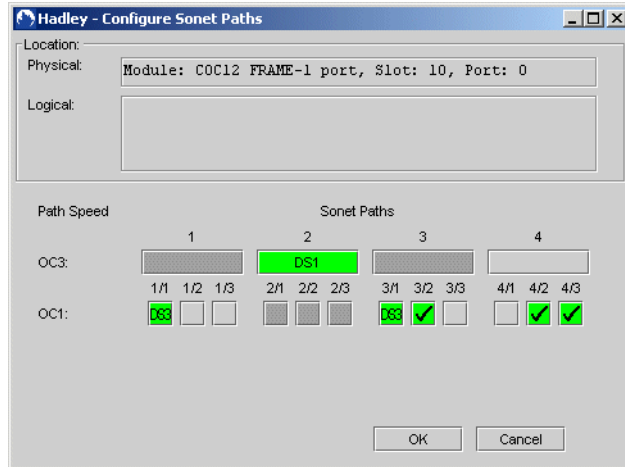

- 3 Select the desired paths by clicking the necessary box(es).



Note: If a line interface has been previously configured with other SONET paths and the paths have DS3 or DS1 interfaces on them, the paths cannot be created or modified until the DS3/DS1 interfaces have been removed.

- 4 Click OK.

The SONET path hierarchy appears in the Instance Explorer.

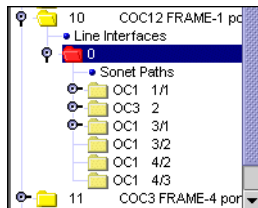

Mapping and Removing DS1 Interfaces on an OC1 SONET Path

You can map a DS1 interface on an OC1 SONET path if there are no other objects on it.

- In T1 mode, 28 DS1 interfaces are created.
- In T3 mode, 21 DS1 interfaces are created.

To map DS1 interfaces:

- 1 Select an OC1 SONET path.
- 2 Right-click and click Map to DS1.

The DS1 Interfaces hierarchy appears in the Instance Explorer.

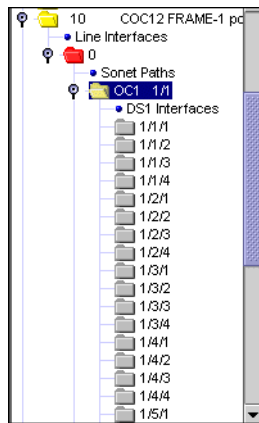

To remove the mapping:

- 1 Select the OC1 SONET path containing the DS1 interfaces.
- 2 Right-click and click Remove DS1s.

The items are deleted.



Note: For information on configuring DS1 interfaces, see *Configuring a DS1 Interface in Chapter 14, Configuring T3/E3 and T1/E1 Modules*.

DS3 Channels

DS3 channels can be found only on OC3-speed SONET paths that are created on cOC3/cOC12 line interfaces set to SDH mode. Each OC3 SONET path has three DS3 channels numbered 1–3. This number is used as the path payload number of any DS1 interface that is created on top of it.

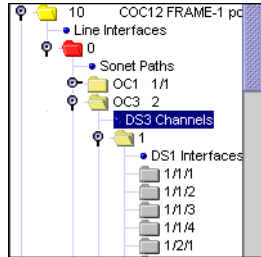

You can map and remove DS1 interfaces on DS3 channels. See the previous section to learn how.

Configuring DS3 Interfaces

A DS3 interface can be created on a SONET path only if the SONET path speed is OC1 and there are no other objects on the SONET path. DS3 interfaces can be channelized or unchannelized. Twenty-eight DS1 interfaces are created when a channelized DS3 interface is created. An unchannelized DS3 interface includes HDLC settings.

Customers are not listable from DS3 interfaces on cOC3/12 modules.



Note: For information on configuring DS1 interfaces, see *Configuring a DS1 Interface in Chapter 14, Configuring T3/E3 and T1/E1 Modules*.

To create a DS3 interface on a SONET path:

- 1 Select an OC1 SONET path.
- 2 Right-click, select Create, and click DS1 Interface.

The Create DS3 Interfaces dialog box appears.

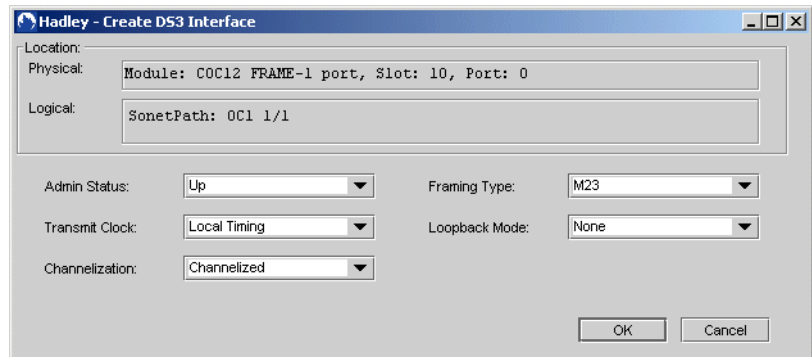

Note: If DS1 interfaces are already mapped to the OC1 SONET path, you must unmap them before trying to create a DS3 interface.

3 Set the DS3 interface parameters (see Table 10-4).

Table 10-4 DS3 interface parameters

Parameter	Description
Admin Status	<ul style="list-style-type: none"> Up – module is enabled Down – module is disabled
Transmit Clock	<ul style="list-style-type: none"> Loop Timing – device receives its clocking from a network source Internal Module – device receives its clocking from a network source Internal Chassis – device receives its clocking from the configured system clock
Channelization	<ul style="list-style-type: none"> Channelized Unchannelized
Framing Type	Method for distinguishing digital channels that have been time-division multiplexed together <ul style="list-style-type: none"> M23 – M23 multiplexer framing CbitParity – c-bit parity framing
Loopback Mode	<ul style="list-style-type: none"> No Loopback – disables loopback mode Line Loopback – loops the data toward the network; connects the received network signal directly to the transmit network signal line. Internal Loopback – loops the data toward the module's interface; connects the local transmitted signal to the local received signal.
HDLC Settings (appears only if Unchannelized was selected during initial creation. Visible later during Configure mode only.)	
CRC Checking Enabled	Cyclical redundancy check (CRC) is an error-checking technique
Data Inversion	Provides <i>ones density</i> , a method for inserting 1s in the data stream. If you enable data inversion on your device, be sure it is also turned on at the other end of the line on the destination device.
MTU	Maximum transmission unit; the largest size allowed for a data packet transmitted over a transmission line; range 4–32763; default 1024 bits
MRU	Maximum receive unit; the largest size allowed for a data packet received over a transmission line; range 4–32763; default 2048
CRC Algorithm	Cyclical redundancy check (CRC) can be set to 16 bits or 32 bits; default 16 bits

4 Click OK.

The DS3 interface and its related DS1 interfaces, are created.

